

HYUNDAI

**1992
Owner's
Manual**

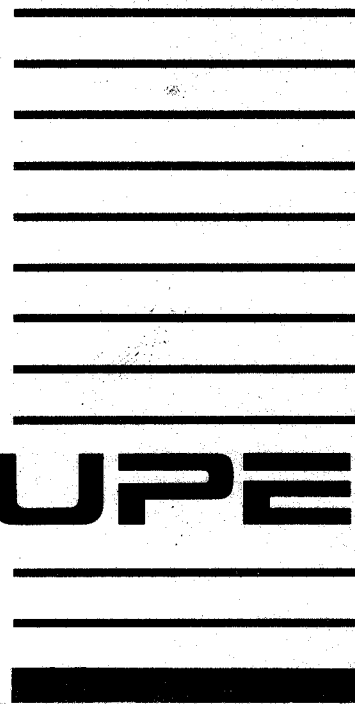

SCOUPE

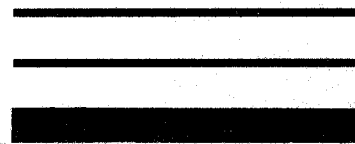

ZA01A2-A

WARRANTIES FOR YOUR HYUNDAI VEHICLE

- o New vehicles 36 months/36,000 Mile Limited Warranty
- o Anti-Perforation Limited Warranty
- o Emission Defect Warranty - Federal Vehicle
- o California Emission Control System Warranty (If applicable)
- o Emission Performance Warranty - Federal Vehicle
- o Replacement Parts and Accessories Limited Warranty
- o Tire Warranty

NOTE

Detailed warranty information is provided in your Hyundai Owner's Handbook.

ZA02A1-A

RESPONSIBILITY FOR MAINTENANCE

The maintenance requirements for your new Hyundai are found in Section 5. As the owner, it is your responsibility to see that all maintenance operations specified by the manufacturer are carried out at the appropriate intervals. When the vehicle is used in severe driving conditions, more frequent maintenance is required for some operations. Maintenance requirements for severe operating conditions are also included in Section 5.

HYUNDAI

SCOUPE

DA03A1-A

1992

OWNER'S MANUAL

Operation

Maintenance

Specifications

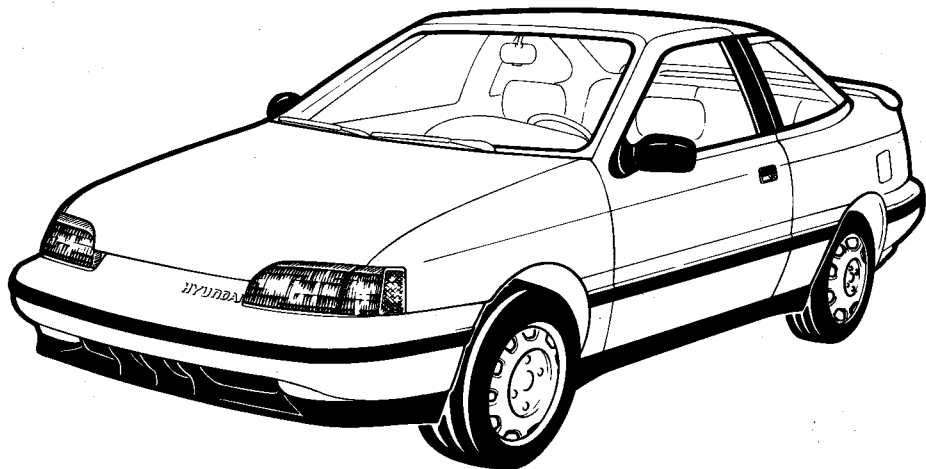

All information in this Owner's Manual is current at the time of publication. However, Hyundai reserves the right to make changes at any time so that our policy of continual product improvement may be carried out.

This manual applies to all 1992 Hyundai Scoupe models and includes descriptions and explanations of optional as well as standard equipment. As a result, you may find material in this manual that does not apply to your specific vehicle.

FOREWORD

Thank you for choosing Hyundai. We are pleased to welcome you to the growing number of discriminating people who drive Hyundais. The advanced engineering and high-quality construction of each Hyundai we build is something of which we're very proud.

Your Owner's Manual will introduce you to the features and operation of your new Scoupe. It is suggested that you read it carefully since the information it contains can contribute greatly to the satisfaction you receive from your new car.

The manufacturer also recommends that all service and maintenance on your car be performed by an authorized Hyundai dealer. Hyundai dealers are prepared to provide high-quality service, maintenance and any other assistance that may be required.

HYUNDAI MOTOR COMPANY

Note: Because future owners will also need the information included in this manual, if you sell this Hyundai, please leave the manual in the vehicle for their use. Thank you.

Copyright 1991 Hyundai Motor Company. All rights reserved. The material in this publication may not be reproduced in any form without written permission from Hyundai Motor Company.

DA06A1-A

CAUTION: MODIFICATIONS TO YOUR HYUNDAI SCOUPE

Your Hyundai should not be modified in any way. Such modifications may adversely affect the performance, safety or durability of your Hyundai and may, in addition, violate conditions of the limited warranties covering the vehicle. Certain modifications may also be in violation of regulations established by the U.S. Department of Transportation and other federal or state agencies.

ZA07A1-A

TWO-WAY RADIO INSTALLATION CAUTION

Your vehicle is equipped with electronic fuel injection and other electronic components. It is possible for an improperly installed/adjusted two-way radio to adversely affect electronic systems. For this reason, we recommend that you carefully follow the radio manufacturers' instructions or consult your Hyundai dealer for precautionary measures or special instructions.

DB00A1-A

1. A GUIDED TOUR

Features of Your Hyundai

FEATURES OF YOUR HYUNDAI

ZB01A1-A

FUEL RECOMMENDATIONS

Use Unleaded Gasoline

Unleaded gasoline with a Pump Octane Rating of 87 (Research Octane Number 91) or higher must be used in your Hyundai.

If leaded gasoline is used, it will cause the catalytic converter to become ineffective and the emission control system to malfunction. This can also result in increased maintenance expense.

To avoid accidental use of leaded fuel, the larger nozzle used with leaded gasoline at service stations cannot be inserted into the fuel tank opening of your Hyundai.

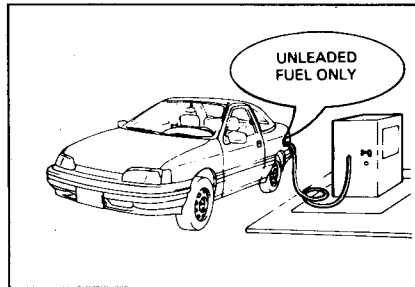

ZB01B1-A

What about Gasohol?

Gasohol (a mixture of 90% unleaded gasoline and 10% ethanol or grain alcohol) may be used in your Hyundai. However, if your engine develops driveability problems, the use of 100% unleaded gasoline is recommended. Use of fuels with unspecified quantities of alcohol, or alcohols other than ethanol, should not be used.

ZB01E1-A

Use of MTBE

Hyundai recommends that fuels containing MTBE (Methyl Tertiary Butyl Ether) over 11.0% vol. (Oxygen Content 2.0% vol.) should not be used in your Hyundai. Fuel containing MTBE over 11.0% vol. (Oxygen Content 2.0% vol.) may reduce vehicle performance and produce vapor lock or hard starting.

ZB01C2-A

Do not Use Methanol

Fuels containing methanol (wood alcohol) should not be used in your Hyundai. This type of fuel can reduce vehicle performance and damage components of the fuel system.

CAUTION:

Your Hyundai's New Vehicle Limited Warranty may not cover damage to the fuel system and performance problems that are caused by the use of fuels containing

methanol or fuels containing MTBE over 11.0% vol. (Oxygen Content 2.0% weight).

ZB01D1-A

Operation in Foreign Countries

If you are going to drive your Hyundai in another country, be sure to:

- o Observe all regulations regarding registration and insurance.
- o Determine that acceptable fuel is available.

ZB02A1-A

BREAKING IN YOUR NEW HYUNDAI During the First 1200 Miles (2000 km)

No formal "break-in" procedure is required with your new Hyundai. However, you can contribute to the economical operation and durability of your Hyundai by observing the following recommendations during the first 1200 miles (2000 km).

- o Don't drive faster than 55 MPH (88 kph).
- o While driving, keep your engine speed (rpm, or revolutions per minute) between 2000 and 4000 rpm.
- o Use moderate acceleration. Don't use full-throttle starts.
- o For the first 200 miles (300 km), try to avoid hard stops.
- o Don't lug the engine (in other words, don't drive so slowly in too-high a gear that the engine "bucks": shift to a lower gear).
- o Whether going fast or slow, vary your speed from time to time.
- o Don't let the engine idle longer than 3 minutes.

FEATURES OF YOUR HYUNDAI

ZB03A1-A

KEYS

For greater convenience, the same key operates all the locks in your Hyundai. However, because the doors can be locked without a key, carrying a spare key is recommended in case you accidentally lock one key inside the car.

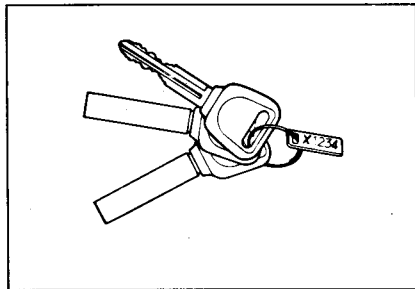

ZB03B1-A

Record Your Key Number

A code number is stamped on the number plate that came with the keys to your Hyundai. This key number plate should not be left with the keys but kept in a safe place, not in the vehicle. The key number should also be recorded in a place where it can be found in an emergency.

If you need additional keys, or if you should lose your keys, your authorized Hyundai dealer can make new keys if you can supply the key number.

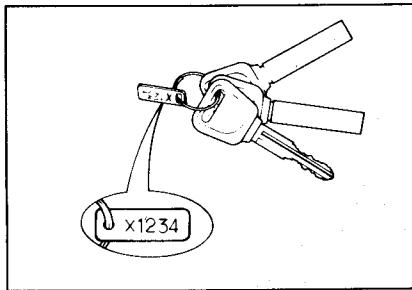

ZB04A1-A

DOOR LOCKS

Before you drive away -- especially if there are children in the car -- be sure that all the doors are securely closed and locked. This helps assure that doors will not be opened accidentally. Also, when combined with the proper use of seat belts, locking the doors helps keep occupants from being ejected from the car in the case of an accident.

ZB04B1-A

Locking Using the Key

Lock the door by turning the key toward the front of the car and unlock it by turning it toward the rear.

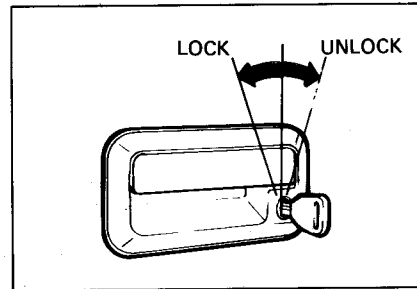

FEATURES OF YOUR HYUNDAI

DB04C1-A

Locking from Outside

The doors can be locked without a key. First push the lock button down, then close the door.

CAUTION:

Be careful not to lock your key in the vehicle.

ZB04D1-A

Locking from Inside

To lock your Hyundai from inside, simply close the door and push the lock button down.

When this is done, the door cannot be opened using either the inside or the outside door handle.

ZB06A1-A

ADJUSTABLE FRONT SEATS

WARNING

Never attempt to adjust the seat while the vehicle is moving. This could result in loss of control, and an accident causing injury to the occupants.

ZB06B1-A

Adjusting Seat Forward and Rearward

To move the seat toward the front or rear, pull the lock release lever toward the center of the car. This releases the seat on its track so you can move it forward or rearward to the desired position. When you find the position you want, release the lever and slide the seat forward or rearward on its track until it locks into position and cannot be moved further.

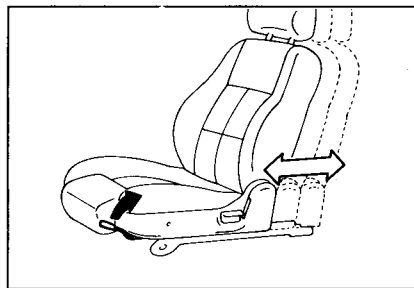
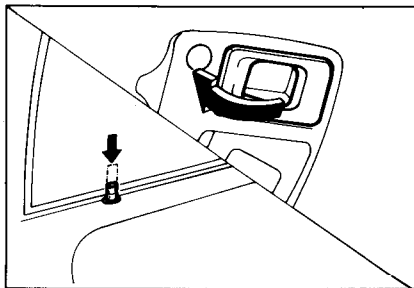
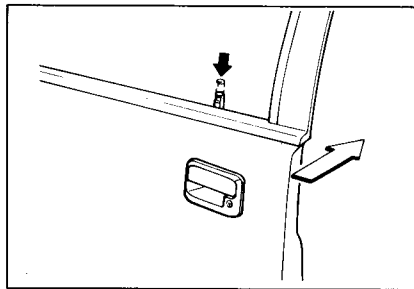

FEATURES OF YOUR HYUNDAI

ZB06C1-A

Adjusting Seatback Angle

To recline the seatback, lean forward to take your weight off it, then pull up on the recliner control lever at the outside edge of the seat. Now lean back until the desired seatback angle is achieved. To lock the seatback into position, release the recliner control lever.

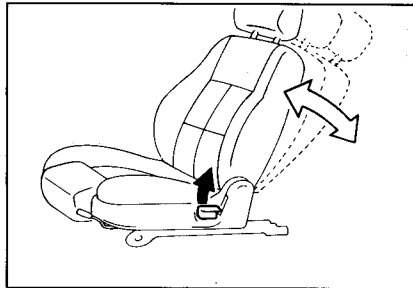

DB06D1-A

Adjustable Headrests

To raise the headrest, pull it up. To lower it, push the headrest down. For maximum effectiveness in case of an accident the headrest should be adjusted so the top of the headrest is at the same height as the top of the occupant's ears. For this reason, the use of a cushion that holds the body away from the seatback is not recommended.

WARNING

Do not operate the vehicle with the headrests removed. Headrests may provide protection against neck injuries when properly adjusted.

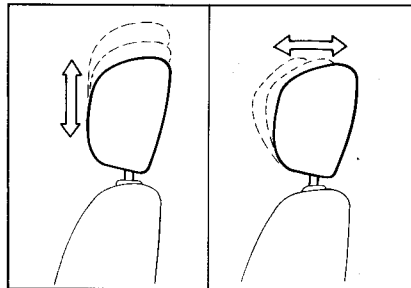

ZB06E1-A

Lumbar Support Control (If installed) (Driver's seat only)

The front seats in some Hyundais are equipped with adjustable lumbar support. To increase the amount of lumbar support, turn the handle forward. To decrease it, turn the handle toward the rear.

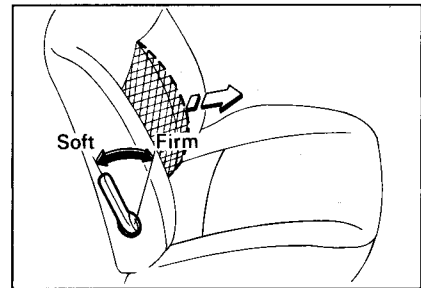

FEATURES OF YOUR HYUNDAI

DB06F1-A

Seat Cushion Height Adjustment (If installed) (Driver's seat only)

To adjust the height of the seat cushion, manually turn the front portion of seat cushion in the desired direction.

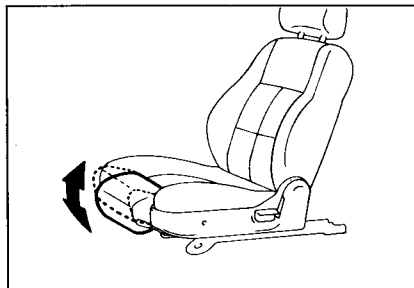

DB07A1-A

REAR SEAT ENTRY

The front passenger seatback should be tilted to enter the rear seat.

By pulling up on the recliner control lever (1) at the outside of the front passenger seat, the seatback will tilt forward and the seat will automatically slide forward.

Rear seat occupants can tilt the front passenger seatback by depressing the foot lever (2) as shown in the drawing.

WARNING

Passengers sitting in the rear seat should be careful not to accidentally press the foot lever (2) while the vehicle is moving. This may cause the seat back to move forward and injure a front seat occupant.

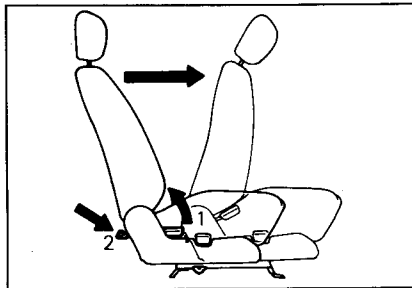

ZB08A1-A

WINDOW GLASS

To raise or lower the window, turn the window regulator handle clockwise or counterclockwise.

NOTE:

When opening or closing the windows, make sure your passenger's arms and hands are safely out of the way.

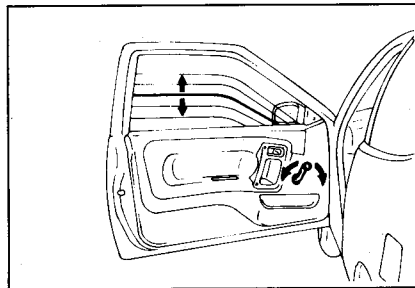

FEATURES OF YOUR HYUNDAI

DB08B1-A

POWER WINDOW (If installed)

The power windows operate only when the ignition key is in the "ON" position. The main switches are located on the driver's side arm rest and control the front windows on the respective sides of the vehicle. The windows may be opened by pressing the lower portion of the switch. The windows may be raised by depressing the upper portion of the switch.

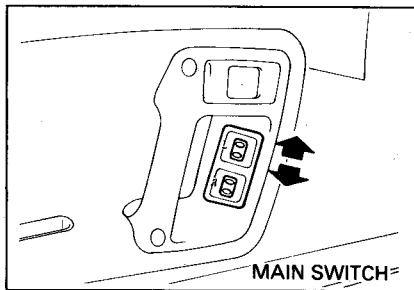

DB08C1-A

CAUTION:

1. **Be careful that head or hands are not trapped by a closing window.**
2. **Never operate the main switch and subswitch in opposing directions at the same time, as the window will stop, and not able to be opened or closed.**
3. **If passengers remain in the car when you leave, especially if a child remains alone, remove the ignition key for their safety.**

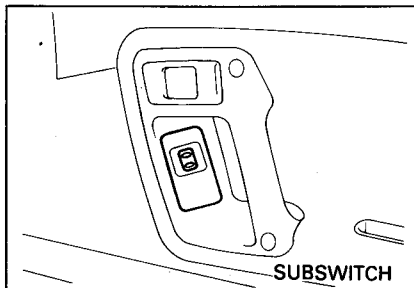

DB09A1-A

SEAT BELT PRECAUTIONS AND WARNINGS

All occupants of the vehicle should wear their seat belts at all times. Your state's laws may require that some or all occupants of the vehicle use seat belts. The possibility of injury or the severity of injury in an accident will be decreased if this safety precaution is observed. In addition, the following recommendations are made:

DB09B1-A

Baby or Small Child

All states require the use of child restraint systems for babies and small children. Whether this is required by law or not, it is strongly recommended that a child restraint seat or infant restraint system be used for babies or small children weighing less than 40 pounds. Information about the use of such restraints is included on page 1-12.

DB09C1-A

Larger Children

It is recommended that larger children occupy the rear seat and wear their seat belts. If the child is in the front seat, he/she should be securely restrained by the seat belt. Under no circumstances should the child be allowed to stand or kneel on any seat. Children are afforded the most safety in the event of an accident when they are restrained by a proper child restraint system.

FEATURES OF YOUR HYUNDAI

ZB09D1-A

Pregnant Women

The use of a seat belt is recommended for pregnant women to lessen the chance of injury in an accident. When a seat belt is used, it should be placed as low and snugly as possible on the hips, not across the abdomen. For specific recommendations, consult a physician.

ZB09E1-A

Injured Person

A seat belt should be used when an injured person is being transported. When this is necessary, you should consult a physician for recommendations.

ZB09F1-A

One Person Per Belt

Two people (including children) should never attempt to use a single seat belt. This could increase the severity of injuries in case of an accident.

DB09G1-A

Do Not Lie Down

To prevent injuries in the event of an accident, and to achieve maximum effectiveness of the seat belt system, all passengers should be sitting up and the front seats should be in an upright position when the car is moving. The seat belt cannot operate properly if the person is lying down in the rear seat or if the front seat is at or near the fully reclined position.

ZB09H1-A

CARE OF SEAT BELTS

Seat belt systems should never be disassembled or modified. In addition, care should be taken to assure that seat belts and belt hardware are not damaged by seat hinges, doors or other abuse.

ZB09I1-A

Periodic Inspection

It is recommended that all seat belts be inspected periodically for wear or damage of any kind. Parts of the system that are damaged should be replaced as soon as possible.

ZB09J1-A

Keep Belts Clean and Dry

Seat belts should be kept clean and dry. If belts become dirty, they can be cleaned using a mild soap solution and warm water. Bleach, dye, strong detergents or abrasives should not be used because they may damage and weaken the fabric.

ZB09K1-A

When to Replace Seat Belts

The entire seat belt assembly or assemblies should be replaced if the vehicle has been involved in an accident. This should be done even if no damage is visible. Additional questions concerning seat belt operation should be directed to your Hyundai Dealer.

DB09L1-A

PASSIVE SEAT BELTS (Front seat)

Your Hyundai is equipped with a new safety seat belt system for the driver and the front seat passenger to be restrained automatically as they sit down and close the door. Your new safety seat belt system consists of a retractor (A), a tab (B), a buckle (C), a knee bolster (D) and a manual lap belt assembly. Always make sure that the metal tab is inserted into the buckle of the upper rear edge of the door before entering your vehicle.

DB09M1-A

WARNING

- o For full restraint system protection, securely fasten the manual lap belt in addition to the automatic shoulder belt.

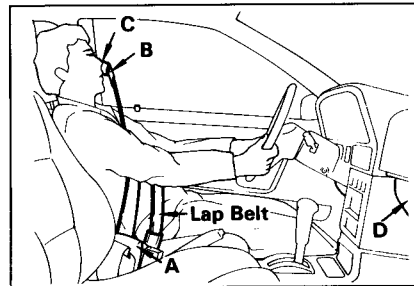

FEATURES OF YOUR HYUNDAI

- o Front seat passengers should not ride in a moving vehicle with the seatback reclined. The seat belts operate securely only when the seatback is in an upright position.
- o Both arms should not be under or over the belt. Rather, one should be over and the other under, as shown in the illustration.
- o Do not wear the shoulder portion of the seat belt under your arm as this increases the possibility of serious injury to you in the event of an accident.
- o When wearing the automatic seat belt, make sure that the belt is positioned midway over the shoulder-NEVER ACROSS THE NECK.
- o To operate the automatic seat belt system, the shoulder belt tab should always remain inserted in the shoulder belt buckle.
- o Do not wear the lap belt across the shoulder belt.
- o Be careful not to damage the belt webbing or hardware, and that they do not get caught or pinched in the seat or doors.
- o Hyundai recommends that children be seated in the rear seats.
- o Avoid wearing twisted seat belts.
- o Release the shoulder belt buckle from the tab only in an emergency.
- o The retractors lock only on sudden impact or stops. The belt will allow some freedom of movement if done slowly.

ZB09N1-A

How The Passive Seat Belt System Works

The metal tab (B) is inserted in the buckle (C) which is fastened firmly to the upper rear edge of the door. The other end of the belt is wound automatically on the Web Locking Retractor (A) under the seat.

When you open the front doors, it extends the belt from the retractor and provides access to the interior. When the door is closed, the belt automatically places itself diagonally across the chest.

The seat belt automatically adjusts to the proper length. If you lean forward in a slow, easy motion, the belt will extend and let you move around. If there is a sudden stop or impact, however, the belt will lock into position. It will also lock if you try to lean forward too quickly.

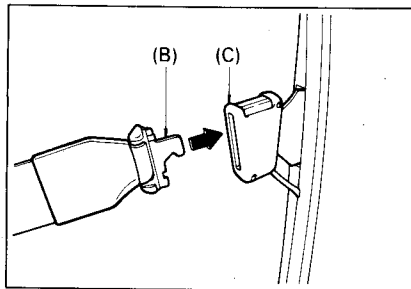

ZB09O1-A

To Release The Seat Belt

If required, press the emergency release button on the buckle (C) marked PRESS EMERGENCY.

When it is released, the belt tab (B) should automatically drawback into the retractor.

For your safety, we recommend that you hold the belt tab (B) with your hand and allow it to retract gently.

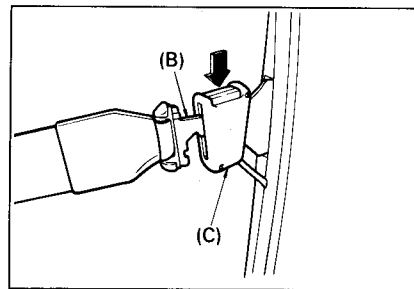

FEATURES OF YOUR HYUNDAI

DB09P1-A

SEAT BELT WARNING LIGHT AND CHIME

With the key in the "ON" position and the lap belt unfastened, the seat belt warning light will stay on and the chime will sound for six seconds. (Driver's only).

If the shoulder belt is disconnected while the key is in the "ON" position, the chime will sound for 6 seconds and the warning light will flash for 60 seconds. (Driver's only).



DB09Q1-A

LAP BELTS (2-Point Emergency Locking Retractor Type) (Front Seat)

To Fasten Your Lap Belt

To fasten your seat belt, pull it out of the retractor and insert the metal tab into the buckle. There will be an audible "click" when the tab locks into the buckle.

The seat belt automatically adjusts to the proper length only after the lap belt is adjusted manually so that it fits snugly around your hips. If you lean forward in a slow, easy motion, the belt will extend and let you move around. If there is a sudden stop or impact, however, the belt will lock into position. It will also lock if you try to lean forward too quickly.

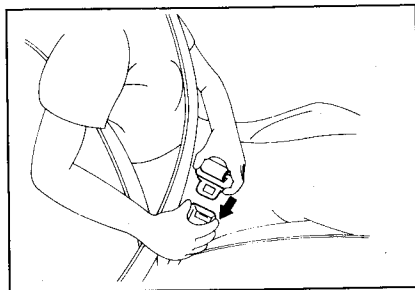

ZB09R1-A

Adjusting Your Lap Belt

You should place the belt as low as possible on your hips, not on your waist. If located too high on your body, the chances of sliding out from under it and being injured are increased. Pull the belt toward the retractor to take up extra slack.

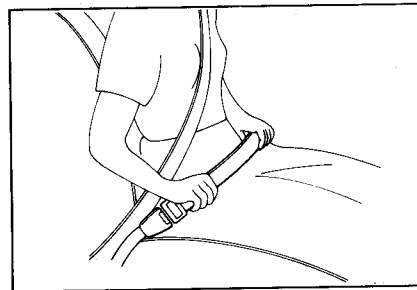

FEATURES OF YOUR HYUNDAI

ZB09S2-A

To Release the Lap Belt

When you want to release the lap belt, press the button in the locking buckle. The lap belt should then retract automatically. If it does not, make sure it is not twisted and try again.

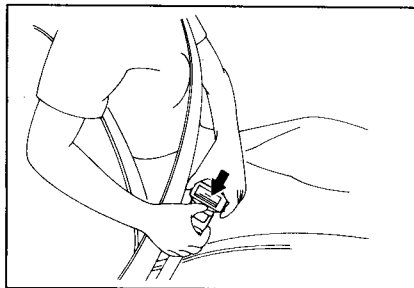

ZB09T1-A

SEAT BELTS

(3-Point Emergency Locking Retractor Type) (Rear seat outboard)

To Fasten Your Belt

To fasten your seat belt, pull it out of the retractor and insert the metal tab into the buckle. There will be an audible "click" when the tab locks into the buckle.

The seat belt automatically adjusts to the proper length only after the lap belt is adjusted manually so that it fits snugly around your hips. If you lean forward in a slow, easy motion, the belt will extend and let you move around. If there is a sudden stop or impact, however, the belt will lock into position. It will also lock if you try to lean forward too quickly.

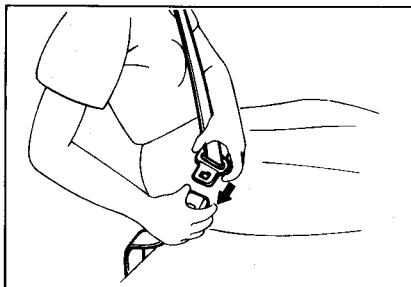

ZB09U1-A

Adjusting Your Seat Belt

You should place the belt as low as possible on your hips, not on your waist. If located too high on your body, the chances of sliding out from under it and being injured are increased. Both arms should not be under or over the belt. Rather, one should be over and the other under, as shown in the illustration.

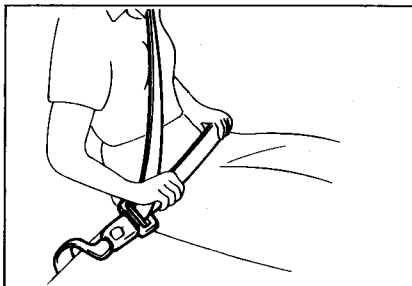

FEATURES OF YOUR HYUNDAI

ZB09V1-A

To Release the Seat Belt

The seat belt is released by pressing the release button in the locking buckle. When it is released, the belt should automatically draw back into the retractor.

If this does not happen, check the belt to be sure it is not twisted, then try again.

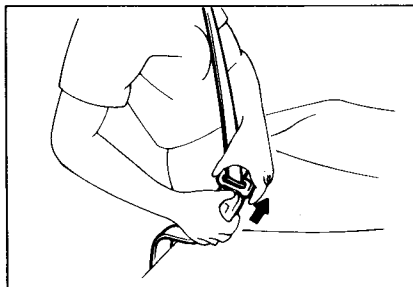

1-12

ZB10A1-A

CHILD RESTRAINT SYSTEM

Children riding in the car should sit in the rear seat and be restrained to minimize the risk of injury in an accident, sudden stop, or sudden maneuver. According to accident statistics provided by the National Highway Traffic Safety Administration (NHTSA), children are safer when properly restrained in the rear seating positions than in the front seat.

Larger children should use one of the seat belts provided. For smaller children, we strongly recommend the use of a commercially available child restraint system that meets the requirements of the Federal Motor Vehicle Safety Standard, (FMVSS), because it offers the most protection against injury. All states now have laws which require that small children must be seated in a child passenger seat restraint system. Check local laws. All child restraint systems are designed to be secured by lap belts or the lap belt portion of a lap-shoulder belt.

Children could be injured in a crash if their restraints are not properly secured. For small children and babies we strongly recommend a child seat or infant seat. Before buying a particular child restraint system, make sure it fits your car seat and seat belts, and fits your child. Follow all the instructions provided by the manufacturer when installing the child restraint system.

DB10B1-A

CAUTION:

- o Since a safety belt or child restraint system can become very hot if it is left in a closed vehicle, be sure and check the seat cover and buckles before placing a child there.
- o When the child restraint system is not in use, store it in the trunk or fasten it with a safety belt so that it will not be thrown forward in the case of a sudden stop or accident.
- o It is recommended that a child restraint system be placed in the vehicle's rear seat since this can make an important contribution to safety.
- o Children who are old enough to sit by themselves should sit in the rear seat and be restrained with the seat belt.
- o Always make sure that the shoulder belt portion of the outboard lap/shoulder belt is positioned midway over the shoulder - never across the neck. The lap belt portion of the lap/shoulder belt or the center seat lap belt must always be positioned as low as possible on your hips, not on your waist. See illustration and instructions on page (1-11).
- o If the seat belt will not properly fit the child, we recommend the use of a suitable booster seat in the rear seat in order to raise the child's seating height so that the seat belt will properly fit the child. Before purchasing a booster seat, make sure that it meets applicable Motor Vehicle Safety

FEATURES OF YOUR HYUNDAI

Standards and that it is satisfactory for use with this vehicle.

- o **Never allow a child to stand up or kneel on any seat.**
- o **Never use an infant carrier or child safety seat that "hooks" over a seatback; it may not provide adequate security in an accident.**
- o **Never allow a child to be held in a person's arms while they are in a moving vehicle. This could result in serious injury to the child in the event of an accident. Holding a child in a moving vehicle does not provide the child with any means of protection during an accident, even if the person holding the child is wearing a seat belt.**

DB10C1-A

Using a Child Restraint System

To install a child hook holder, use a 5/16"

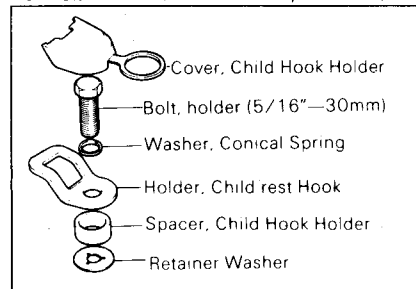

18 UNC threaded bolt and 11mm spacer. You can damage the holder nut on your vehicle if you force a bolt with a different thread into the holder nut.

In addition to the bolt, you may also need a spacer and a locking clip depending on the vehicle or the position in which the child seat is installed.

If these parts do not come with your child seat, you can purchase them from your Hyundai dealer.

DB10D1-A

CHILD HOOK HOLDER NUT LOCATION

The child hook holder nut is located on the rear deck as shown below.

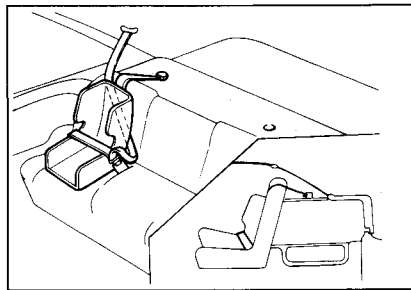

DB10G1-A

Outboard Shoulder/Lap Belt

Secure the child restraint with the lap belt as illustrated. To prevent slack in the lap belt, it will be necessary to secure the lap/shoulder belt in place with a locking clip. If your child restraint has a top strap, install the child rest hook holder to the provided anchor. Secure the child restraint with the outboard lap belt of the rear seat and latch the top strap hook onto the anchor bracket.

NOTE:

- o **Before using the locking clip, read the instructions supplied by the manufacturer.**
- o **Child restraint anchors are designed to withstand only those loads imposed by correctly fitted child restraints. Under no circumstances are they to be used for adult seat belts or harnesses.**

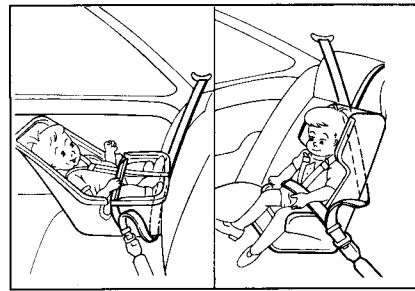

FEATURES OF YOUR HYUNDAI

DB10H1-A

Installation on Front Seat:

To install a child restraint system in the front of your vehicle, a seat belt locking clip is required.

Secure the child restraint system with the lap belt, as shown in the illustration, below. To prevent looseness of the lap belt, use a genuine Hyundai locking clip (available from your Hyundai dealer) or one of equivalent dimension and strength. To install the locking clip, insert the lap belt through the recesses of the locking clip near the top of the lap belt, as shown in the illustration. (Follow the instructions attached to the locking clip for its use).

When your child restraint system is not installed, the locking clip should be stored in the glove box to prevent it from being lost.

To use a child hook, pull out the rear seat belt and then allow it to rewind back to where it locks. Latch the hook onto the tab of the rear seatbelt and tighten the strap of the child seat.

NOTE:

- o Be sure to secure the child restraint system with the lap belt when using a child hook.
- o On automatic restraint vehicles, it is not recommended that a child restraint system be placed in the front seat.

DB10H1-A

Adjusting The Lap Belt (Front seat)

To prevent slack in the lap belt, it will be necessary to secure the lap belt when you use the child restraint system. Secure the child restraint with the lap belt as illustrated.

1. Pull the lap belt out fully.
2. Tie up the slack of the lap belt using the locking clip at any convenient point along the lap belt. Make the loop as large as possible to remove any slack.
3. After you have tied up the belt, pull on it in the direction of the arrows to make sure that it does not slip.

WARNING

Never install the child restraint with the automatic seat belt, it is not designed for this purpose. Failure to follow this warning may result in injury to the child.

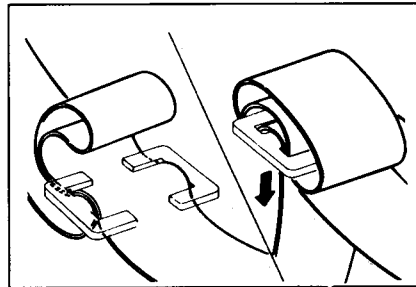
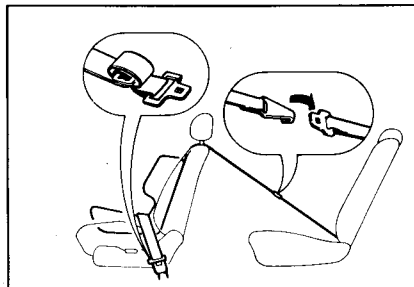
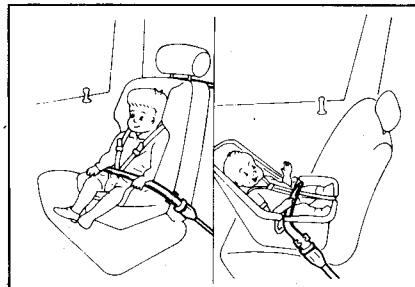

FEATURES OF YOUR HYUNDAI

DB11A1-A

INSTRUMENTS AND CONTROLS

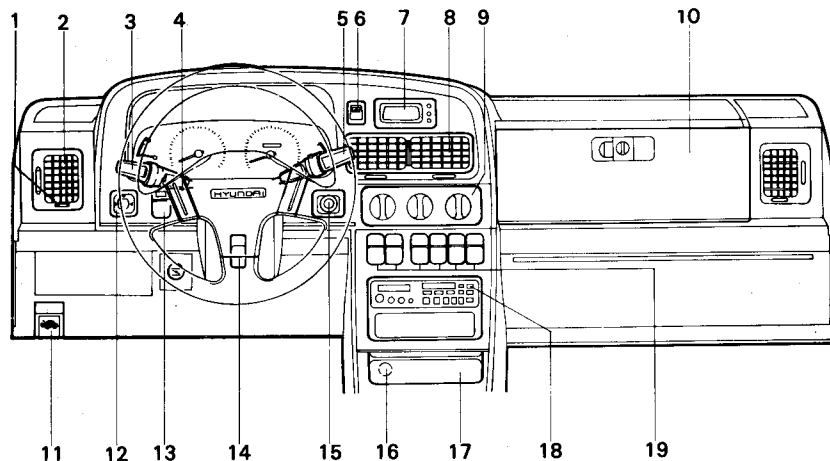

1. Side Air Vent Knob
2. Side Air Vent
3. Multi-Function Light Switch
4. Horn Button
5. Windshield Wiper/Washer Switch
6. Hazard Warning Switch
7. Digital Clock
8. Center Air Vent

9. Heater/Air Conditioner Control Panel
10. Glove Box
11. Hood Release Lever
12. Outside Rear-view Mirror Control Switch
(If installed)
13. Remote Trunk Lid Release Switch
14. Steering Wheel Tilt Lever

15. Panel Illumination Control Knob
(Rheostat switch)
16. Cigarette Lighter
17. Ash tray
18. Audio System
19. Control Switches

FEATURES OF YOUR HYUNDAI

DB11B1-A

INSTRUMENT CLUSTER AND INDICATORS

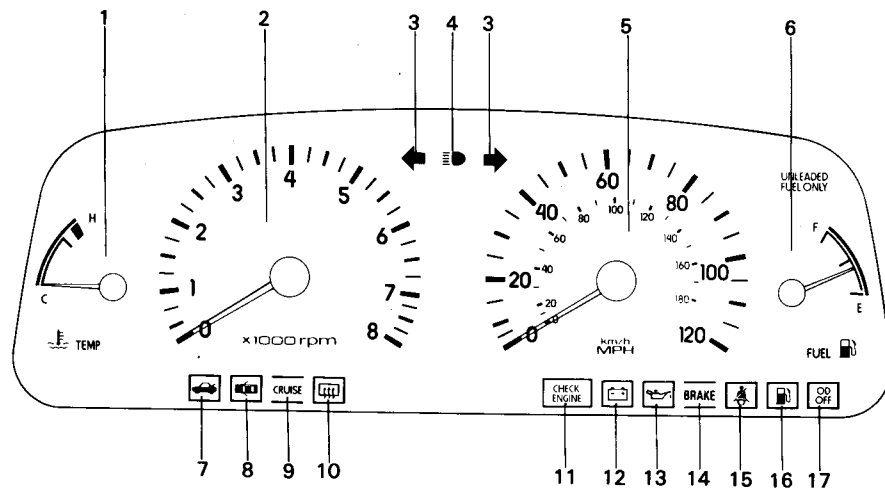

1. Temperature Gauge
2. Tachometer
3. Turn Signal Indicator Light
4. High Beam Indicator Light
5. Speedometer
6. Fuel Gauge
7. Trunk Lid Open Warning Light

8. Door Ajar Warning Light
9. Cruise Control Indicator Light
10. Rear Window Defroster Indicator
11. Engine Warning Light
12. Charging System Warning Light
13. Oil Pressure Warning Light

14. Parking Brake/Brake Fluid Level Warning Light
15. Seat Belt Warning Light
16. Low Fuel Warning Light
17. Overdrive Off Indicator Light (If installed)

FEATURES OF YOUR HYUNDAI

ZB11E1-A



OVERDRIVE/OFF INDICATOR

When the overdrive switch is turned on and 4th gear is engaged, the overdrive off indicator will go out. This amber indicator will be illuminated when the overdrive switch is turned off.

ZB11F1-A



REAR WINDOW DEFROSTER INDICATOR LIGHT

The rear window defroster indicator light comes on when the ignition switch is on and the rear window defroster is switched to "ON". The defroster will turn itself off in about 10 minutes.

ZB11G1-A



TURN SIGNAL INDICATOR LIGHTS

The blinking green arrow on the instrument panel shows the direction indicated by the turn signals. If the arrow comes on but does not blink, blinks more rapidly than normal, or does not blink at all, a malfunction in the turn signal system is indicated.

ZB11H1-A



SEAT BELT REMINDER LIGHT AND CHIME

The seat belt reminder light comes on for 6-60 seconds when the ignition key is turned from the "OFF" position to "ON" or "START". If the driver's seat belt is not fastened, the warning chime will sound at the same time.

ZB11J1-A



HIGH BEAM INDICATOR LIGHT

The high beam indicator light comes on whenever the headlights are switched to high beam.

DB11K1-A



OIL PRESSURE WARNING LIGHT

CAUTION:

If the oil pressure warning light stays on while the engine is running, serious engine damage may result. The oil pressure warning light comes on whenever there is insufficient oil pressure. In normal operation, it should come on when the ignition switch is turned on, then go out when the engine is started. If the oil pressure warning light stays on while the engine is running, there is a serious malfunction.

If this happens, stop the car as soon as it is safe to do so, turn off the engine and check the oil level. If the oil level is low, add engine oil until the proper level is obtained and start the engine again. If the

light stays on with the engine running, turn the engine off immediately. In any instance where the oil light stays on when the engine is running, the engine should be checked by a Hyundai dealer before the car is driven again.

ZB11L1-A



PARKING BRAKE/BRAKE FLUID LEVEL WARNING LIGHT

CAUTION:

If you suspect brake trouble, have your brakes checked by a Hyundai dealer as soon as possible. Driving your car with a problem in either the brake electrical system or brake hydraulic system is dangerous, and could result in an accident.

Warning Light Operation

The parking brake/brake fluid level warning light should come on when the parking brake is applied and the ignition switch is turned to "ON" or "START". After the engine is started, the light should go out when the parking brake is released.

If the parking brake is not applied, the warning light should come on when the ignition switch is turned to "ON" or "START", then go out when the engine starts. If the light comes on at any other time, you should slow the vehicle and bring it to a complete stop in a safe location off the roadway.

FEATURES OF YOUR HYUNDAI

The brake warning light indicates that the brake fluid level in the brake master cylinder is low and hydraulic brake fluid conforming to DOT 3 specifications should be added. After adding fluid, if no other trouble is found, the car should be carefully driven to a Hyundai dealer for inspection. If further trouble is experienced, the vehicle should not be driven at all but taken to a dealer by a professional towing service or some other safe method.

Your Hyundai is equipped with a dual-diagonal braking system. This means you still have braking on two wheels even if one of the dual systems should fail. With only one of the dual systems working, more than normal pedal travel and greater pedal pressure are required to stop the car. Also, the car will not stop in as short a distance with only half of the brake system working. If the brakes fail while you are driving, shift to a lower gear for additional engine braking and stop the car as soon as it is safe to do so.

ZB11M1-A



CHARGING SYSTEM WARNING LIGHT

The charging system warning light should come on when the ignition is turned on, then go out when the engine is running. If the light stays on while the engine is running, there is a malfunction in the electrical charging system. If the light comes on while you are driving, stop, turn off the engine and check under the

hood. First, make certain the alternator drive belt is in place. If it is, check the tension of the belt. Do this as shown on page 6-13 by pushing down on the center of the belt.

DB11N1-A



TRUNK LID OPEN WARNING LIGHT

This light remains on unless the trunk lid is completely closed.

ZB11Q1-A



DOOR AJAR WARNING LIGHT AND CHIME

The door ajar warning light and chime warns you that a door is not completely closed.

NOTE:

To remind you not to lock the key inside the car, the warning chime sounds and the warning light comes on whenever the key is in the "LOCK" position and the door is open. The chime sounds and the light remains on until the key is removed from the ignition.

ZB11P1-A



LOW FUEL LEVEL WARNING LIGHT

The low fuel level warning light comes on when the fuel tank is approaching empty. When it comes on, you should add fuel as soon as possible. Driving with the fuel level warning light on or with the fuel level below "E" can cause the engine to misfire and damage the catalytic converter.

DB11Q1-A



ENGINE WARNING LIGHT

This light illuminates when there is a malfunction of an exhaust gas related component, and the system is not functioning properly so that the exhaust gas regulation values are not satisfied. This light will also illuminate when the ignition key is turned to the "ON" position. It will go out after a few seconds. If it illuminates while driving, or does not illuminate when the ignition key is turned to the "ON" position, take your car to your nearest authorized dealer and have the system checked.

FEATURES OF YOUR HYUNDAI

DB11R1-A

BRAKE PAD WEAR WARNING SOUND

The front disc brake pads have wear indicators that should make a high-pitched squealing or scraping noise when new pads are needed. The sound may come and go or be heard all the time when the vehicle is moving. It may also be heard when the brake pedal is pushed down firmly. Expensive rotor damage will result if the pads are not promptly replaced.

ZB11S1-A

FUEL GAUGE

The needle on the gauge indicates the fuel level in the fuel tank. The fuel capacity is given in Section 9.

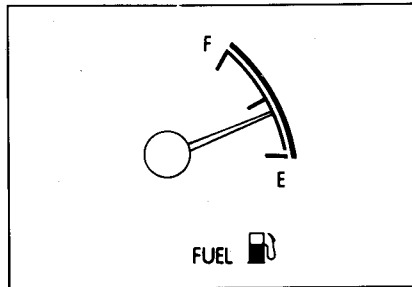

ZB11T1-A

COOLANT TEMPERATURE GAUGE

WARNING

Never remove the radiator cap when the engine is hot. The coolant is under pressure and could erupt and cause severe burns. Wait until the engine is cool before adding coolant.

The needle on the coolant temperature gauge should stay in the normal range. If it moves across the dial to "H" (Hot), pull over and stop as soon as possible and turn off the engine. Then open the hood and check the coolant level in the plastic tank at the right side of the engine compartment.

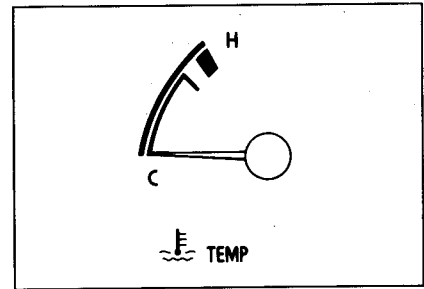

FEATURES OF YOUR HYUNDAI

ZB11U1-A

SPEEDOMETER

Your Hyundai's speedometer is calibrated in miles per hour (on the outer scale) and kilometers per hour (on the inner scale).

DB11V1-A

ODOMETER

The odometer records the total distance traveled in miles and tenths of a mile. You will also find the odometer useful to determine when periodic maintenance should be performed.

NOTE:

Federal law forbids alteration of the odometer of any vehicle. Changing the number of miles shown on the odometer may void your warranty coverage.

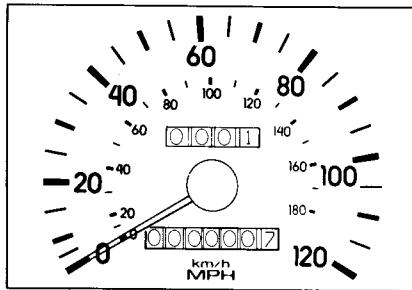

1-20

ZB11W1-A

TRIP ODOMETER

The trip odometer records distance in miles and tenths of a mile. It is equipped with a push-button reset feature. This allows you to return the trip odometer to zero by pushing in on the small knob beside the speedometer.

ZB11X2-A

TACHOMETER

The tachometer registers the speed of your engine in revolutions per minute (rpm). It is useful to help you shift at the appropriate engine speed to avoid lugging or over-revving the engine.

CAUTION:

The engine should not be raced to such a speed that the needle enters the red zone on the tachometer face. This can cause severe engine damage.

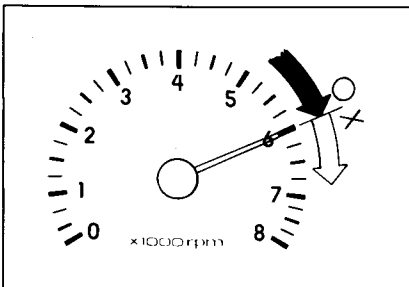

DB12A1-A

COMBINATION TURN SIGNAL, HEADLIGHT, AND LOW-BEAM SWITCH

Turn Signal Operation

Pulling down on the lever causes the turn signals on the left side of the car to blink. Pushing upwards on the lever causes the turn signals on the right side of the car to blink. As the turn is completed, the lever will automatically return to the center position and cancel the turn signals at the same time. If either turn signal indicator light blinks more rapidly than usual, goes on but does not blink, or does not go on at all, there is a malfunction in the system. Check for a burned-out fuse or bulb, or see your Hyundai dealer.

ZB12B1-A

Lane Change Signal

To indicate a lane change, move the lever up or down to a point where it begins flashing.

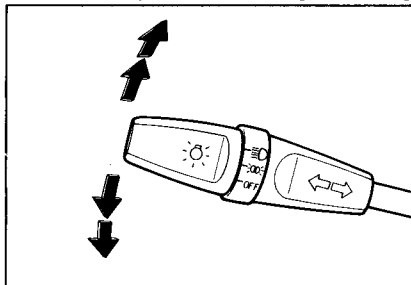

FEATURES OF YOUR HYUNDAI

The lever will automatically return to the center position when released.

ZB12C1-A

HEADLIGHT SWITCH

To operate the headlights, turn the barrel on the end of the multi-function switch. The first position turns on the parking lights, sidelights, tail lights and instrument panel lights. The second position turns on the headlights.

ZB12D1-A

HIGH-BEAM SWITCH

To turn on the headlight high beams, push the lever forward (away from you). The High Beam Indicator Light will come on at the same time. For low beams, pull the lever back toward you.

ZB12E1-A

HEADLIGHT FLASHER

To flash the headlights, pull the switch lever toward you, then release it. The headlights can be flashed even though the headlight switch is in the "OFF" position.

ZB13A1-A

WINDSHIELD WIPER AND WASHER SWITCH

The windshield wiper switch has three positions:

1. Intermittent wiper operation
2. Low-speed operation
3. High-speed operation

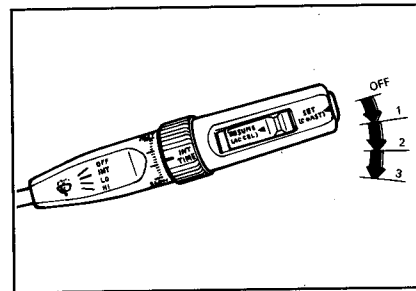
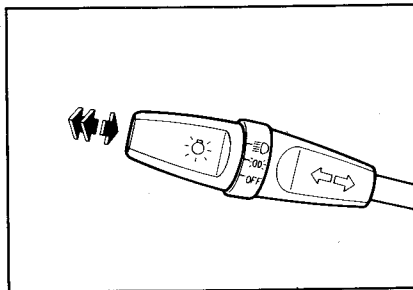
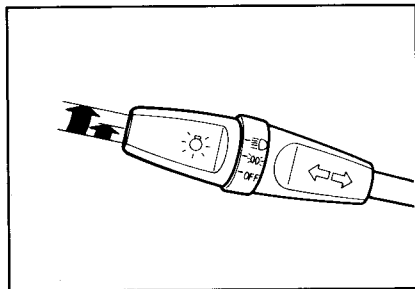

FEATURES OF YOUR HYUNDAI

DB13B1-A

WINDSHIELD WASHER OPERATION

To use the windshield washer, pull the wiper/washer lever toward the steering wheel. When the washer lever is operated, the wipers automatically make two passes across the windshield. The washer continues to operate as long as the button is depressed.

NOTE:

- o Do not operate the washer more than 15 seconds at a time or when the fluid reservoir is empty.
- o In icy or snowy weather, be sure the wiper blades are not frozen to the glass prior to operating the wipers.

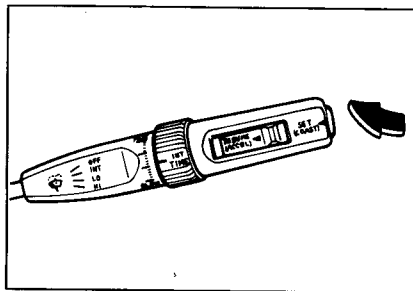

ZB14A1-A

ADJUSTABLE INTERMITTENT WIPER OPERATION

To use the intermittent wiper feature, place the wiper switch in the "INT" position. With the switch in this position, the interval between wipes can be varied from 2 to 10 seconds by turning the Interval Adjuster Switch.

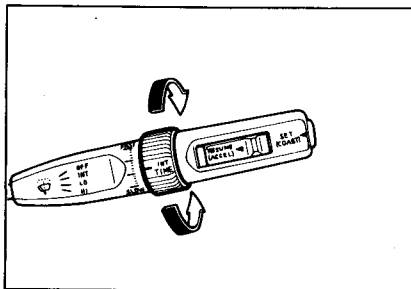

DB16A1-A

HAZARD WARNING SYSTEM

The hazard warning system should be used whenever you find it necessary to stop the car in a hazardous location. When you must make such an emergency stop, always pull off the road as far as possible. The hazard warning lights are turned on by pushing in on the hazard switch. This causes all turn signal lights to blink. The hazard warning lights will operate even though the key is not in the ignition. To turn the hazard warning lights off, push in on the switch a second time.

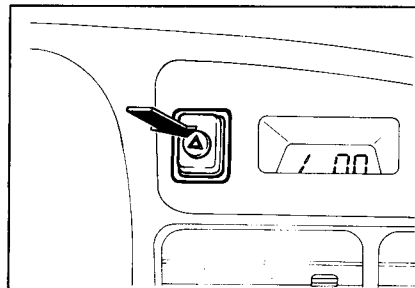

FEATURES OF YOUR HYUNDAI

ZB17A1-A

REAR WINDOW DEFROSTER SWITCH

The rear window defroster is turned on by pushing in on the switch. At the same time, the rear window defroster indicator light is turned on. To turn the defroster off, push in on the switch a second time.

The rear window defroster automatically turns itself off after about 10 minutes. To restart the defroster cycle, push in on the switch again after it has turned itself off.

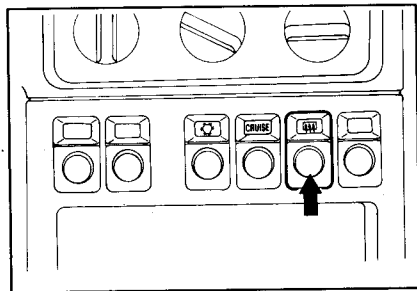

ZB19A2-A

DIGITAL CLOCK

There are three control buttons for the digital clock. Their functions are:

HOUR - Push "Hour" to advance the hour indicated.

MIN - Push "Min" to advance the minute indicated.

SET - Push "SET" to reset minutes to ":00" to facilitate resetting the clock to the correct time. When this is done:

Pressing "SET" between 10 : 30 and 11 : 29 changes the readout to 11 : 00. Pressing "SET" between 11 : 30 and 12 : 29 changes the readout to 12 : 00.

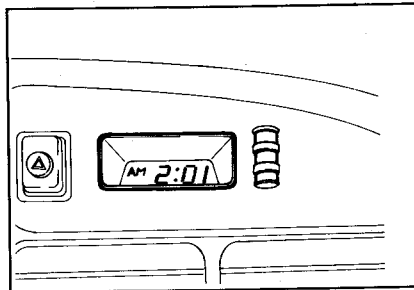

ZB20A1-A

INSTRUMENT PANEL LIGHT CONTROL (RHEOSTAT)

The instrument panel lights can be made brighter or dimmer by turning the instrument panel light control knob.

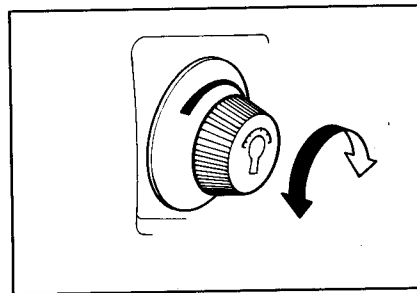

FEATURES OF YOUR HYUNDAI

DB21A1-A

CIGARETTE LIGHTER

For the cigarette lighter to work, the key must be in the "ACC" position or the "ON" position.

To use the cigarette lighter, open the cigarette lighter and ashtray cover, push the cigarette lighter all the way into its socket. When the element has heated, the lighter will pop out to the "ready" position.

Do not hold the cigarette lighter in. As this can damage the heating element and create a fire hazard.

If it is necessary to replace the cigarette lighter, use only a genuine Hyundai replacement or its approved equivalent.

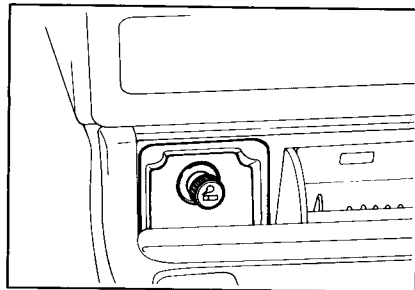

DB22A1-A

FRONT ASHTRAY

The ashtray is located on the front main console. The front ashtray may be opened by pulling out at the top edge.

To remove the ashtray, press down on the spring-loaded tab inside the ashtray and pull all the way out.

The ashtray light will only illuminate when the external lights are on.

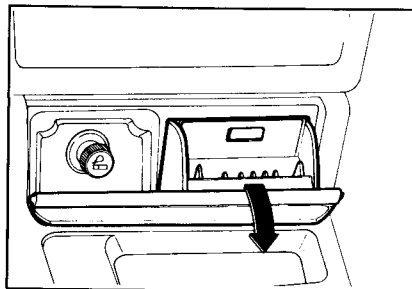

DB23A1-A

DRINK HOLDER (If installed)

The drink holder is located on the front main console for holding cups or cans in its holes. The drink holder can be used by pulling out on the slider handle.

CAUTION:

- o Place the drink holder in its original position while not in use.
- o Do not place anything else on the drink holder. Such objects can be thrown out, possibly injuring persons in the vehicle during sudden braking or in an accident.

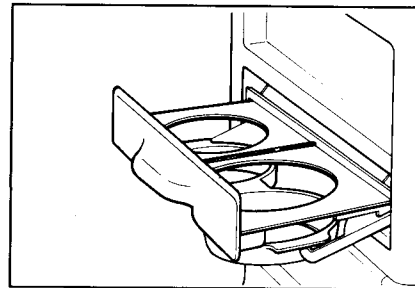

FEATURES OF YOUR HYUNDAI

DB24A1-A

SUNROOF (Manual Type) (If installed)

The sunroof can be manually opened or closed. To open, pull the lever all the way toward the arrow indicated in the illustration. Push the lever at the center to lock the window in the open position. To close, pull the lever toward you. After the window has been closed, lock the lever back into position. Be sure that the glass is securely closed.

CAUTION:

Do not open the sunroof in severe cold temperature or when it is covered with ice or snow.

WARNING

Do not close a sunroof if anyone's hands, arms or other body parts are between the glass and the sunroof sash as this may cause an injury.

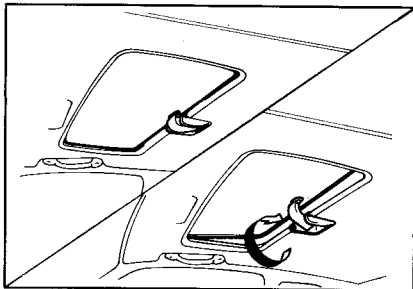

DB24B1-A

To Remove the Sunroof

1. Pull the lever all the way downward.
2. Release the hinge and push the sunroof glass upward in the direction of the arrows indicated in the illustration.
3. Now, you can easily remove the sunroof glass from the roof panel.

NOTE:

There is a storage bag in the trunk. Place the sunroof glass into the storage bag and store so it will not broken.

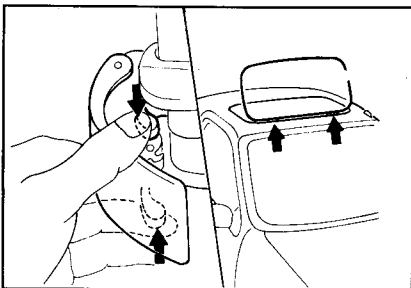

ZB70A1-A

SUN SHADE

Your Hyundai is also equipped with a sunshade which can block out sunlight entirely.

WARNING

Never install or remove the sun shade while driving.

To install the sun shade.

1. Install the hook into the holder attached on the front of the sunroof.
2. Slide and lock the sun shade into the catch.

CAUTION:

- o There is a storage bag in the trunk. Place the sun shade into the storage bag and store it in the trunk. Be careful not to place heavy things on the bag, otherwise it may be deformed or broken.
- o Installation or removal of the sun shade should be done with the sunroof closed.

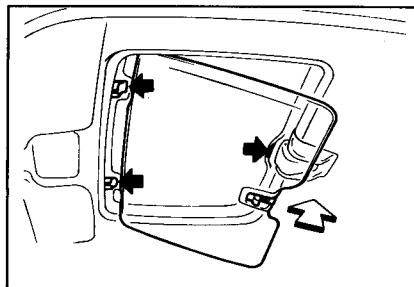

FEATURES OF YOUR HYUNDAI

DB25A1-A

INTERIOR LIGHT

The interior courtesy light has a 3-position switch. The three positions are:

- o "o" In the "MIDDLE" position, the interior courtesy light comes on when any door is opened, then goes out when it is closed.
- o "OFF" In the "RIGHT" position, the light stays off even though a door is open.
- o "ON" In the "LEFT" position, the light stays on at all times.

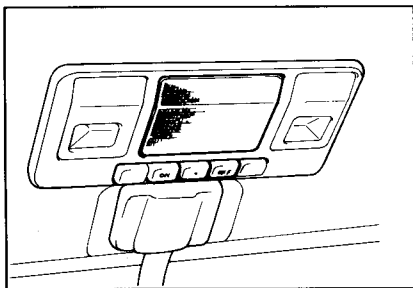

DB25B1-A

MAP LIGHT

Push in the MAP LIGHT switch to turn the light on or off. This light produces a spot beam for convenient use as a map light at night or as a personal light for the driver or the passenger.

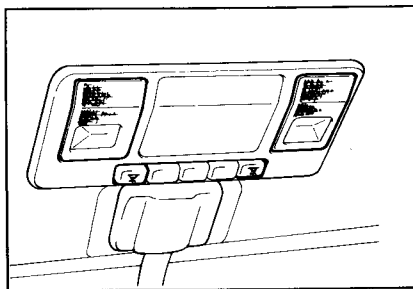

ZB26A1-A

GLOVE BOX

WARNING

To avoid the possibility of injury in case of accident or a sudden stop, the glove box door should be kept closed when the car is in motion.

- o To open the glove box, pull on the glove box release lever.
- o The glove box door can be locked (and unlocked) with the key.

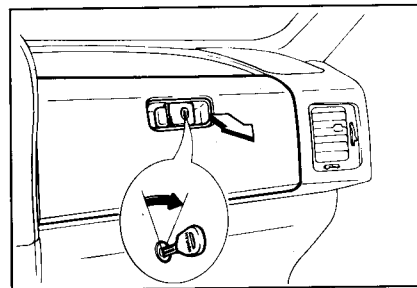

FEATURES OF YOUR HYUNDAI

ZB27A2-A

OUTSIDE REAR VIEW MIRROR

Manual Type

The outside rear view mirror on the driver's side is equipped with a remote control. It is operated by the control lever in the bottom front corner of the window.

Before driving, always check that your mirror is positioned so you can see directly behind you. When using the mirror, always exercise caution when attempting to judge the distance of vehicles behind you.

NOTE:

If the mirror control is jammed with ice, do not attempt to break it free using the control handle or by manipulating the face of the mirror. Use an approved spray de-icer (not radiator antifreeze) to release the frozen mechanism or move the vehicle to a warm place and allow the ice to melt.

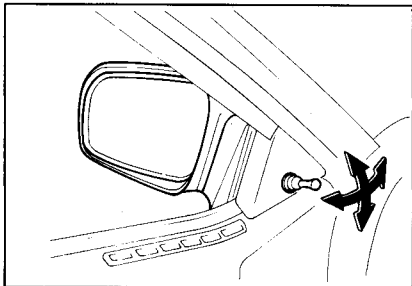

DB27B1-A

Electric Type (If installed)

The outside rear-view mirror can be adjusted in any direction to give the maximum rear-view vision.

The remote control outside rear-view mirror switch controls the adjustments for both the right and left door mirrors.

To adjust the position of either mirror:

1. Move the selecting switch to the right or left to activate the adjustable mechanism for the corresponding door mirror.
2. Adjust the mirror angle by depressing the appropriate perimeter switch as illustrated.

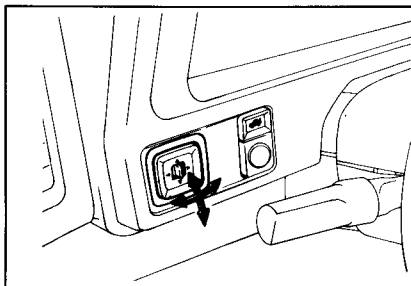

DB27C1-A

CAUTION:

- o Do not leave the switch on for an unnecessary length of time.
- o Scraping ice from the mirror face could cause permanent damage. To remove any ice, use a sponge, soft cloth or approved de-icer.
- o Be careful when judging the size or distance of any object seen in the passenger side rear view mirror. It is a convex mirror with a curved surface, any objects seen in this mirror are closer than they appear.

FEATURES OF YOUR HYUNDAI

ZB28A1-A

DAY/NIGHT REAR VIEW MIRROR

Your Hyundai is equipped with a day/night inside rear view mirror.

The "night" position is selected by flipping the tab at the bottom of the mirror toward you. In the "night" position, the glare of headlights of cars behind you is reduced.

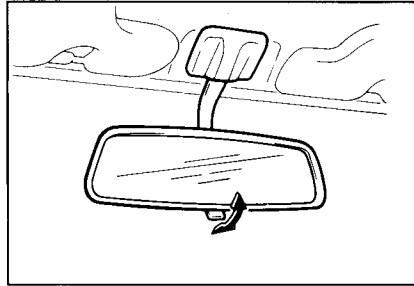

ZB29A1-A

PARKING BRAKE

Always engage the parking brake before leaving the car. This also turns on the parking brake indicator light when the key is in the "ACC" or "ON" position. Before driving away, be sure that the parking brake is fully released and the indicator light is off.

- o To engage the parking brake, pull the lever up as far as possible.
- o To release the parking brake, pull up and press the thumb button. Then, while holding the button in, lower the brake lever.

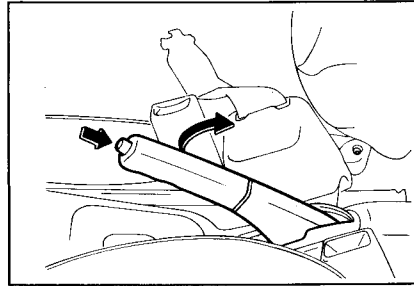

DB30A1-A

FOLD DOWN REAR SEAT BACKS

For greater convenience, the seat backs may be folded down individually.

- o To unlock the seat back, pull the seat back locking knob, then pull forward on the seat back.
- o When you return the seat back to its upright position, always be sure it has locked into position by pulling and pushing on the top of the seat back.

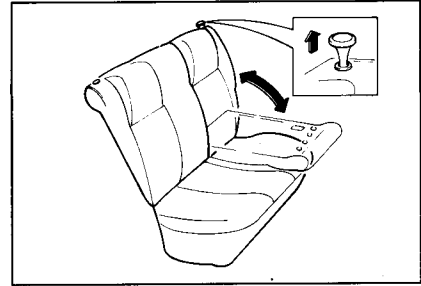

FEATURES OF YOUR HYUNDAI

DB30B1-A

WARNING

The purpose of the fold-down rear seat backs is to allow you to carry longer objects than could be accommodated.

Do not allow passengers to sit on top of the folded-down seat back while the car is moving as this is not a proper seating position and no seat belts are available for use. This could result in injury in case of an accident or sudden braking. Objects carried on the folded-down seat back should not extend higher than the top of the front seats. This could allow cargo to slide forward and cause injury or damage during sudden stops.

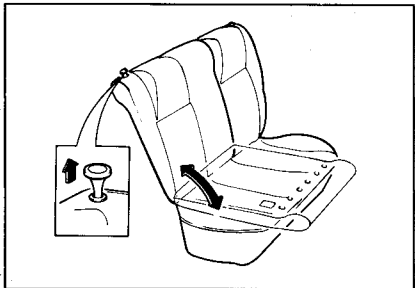

DB31A1-A

TRUNK LID

WARNING

The trunk lid should always be kept completely closed while the vehicle is in motion. If it is left open or ajar, poisonous exhaust gases may enter the car resulting in sickness or serious injury to the occupants. See additional warnings concerning exhaust gases on page 2-2.

- o The trunk lid is opened by turning the key clockwise to release the lock, then raising the door manually.
- o To close, lower the door, then press down on it until it locks. To be sure the door is securely fastened, always try to pull it up again.

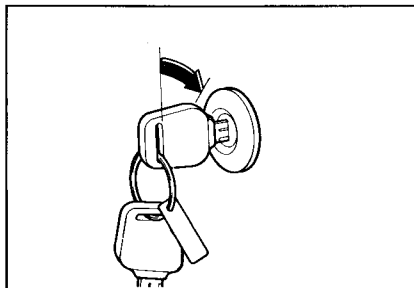

DB33A1-A

REMOTE TRUNK LID RELEASE

The trunk lid is opened by pressing the button to release the lock, then raising the door manually.

To close, lower the door, then press down on it until it locks. To be sure the door is securely fastened, always try to pull it up again.

NOTE:

The trunk lid is released by a two step release switch. To release the trunk lid push the trunk lid switch once then push the switch firmly a second time.

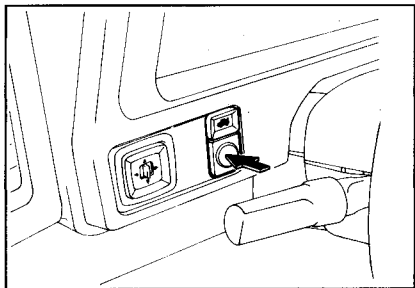

FEATURES OF YOUR HYUNDAI

ZB34A2-A

HIGH-MOUNTED REAR STOP LIGHT

In addition to the lower-mounted rear stop lights on either side of the car, the high mounted rear stop light in the center of the rear window or rear spoiler also comes on when the brakes are applied.

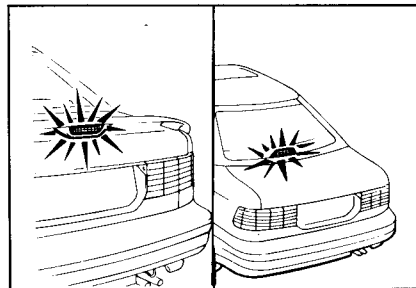

ZB36A2-A

REMOTE FUEL FILLER LID RELEASE

The fuel-filler lid may be opened from inside the vehicle by pulling up on the fuel-filler lid release.

NOTE:

If the fuel-filler lid will not open because ice has formed around it, tap lightly or push on the lid to break the ice and release the lid. Do not pry on the lid. If necessary, spray around the lid with an approved de-icer fluid (do not use radiator anti-freeze) or move the vehicle to a warm place and allow the ice to melt.

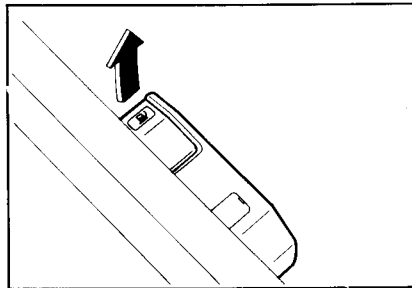

ZB36B2-A

Manual Fuel Filler Lid Release

If the fuel filler lid cannot be opened by pulling the remote opener, a manual opener handle is located inside the trunk on the left side. Open the fuel filler lid by pulling on this handle as shown below.

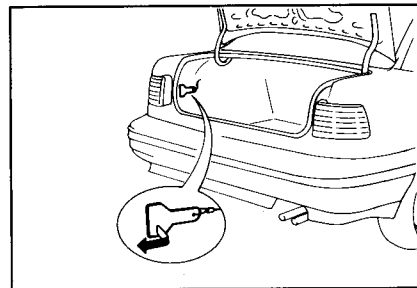

FEATURES OF YOUR HYUNDAI

ZB35B1-A

WARNING

Gasoline vapors are dangerous. Before refueling, always stop the engine and never allow sparks, lit cigarettes or open flames near the filler area. If you need to replace the filler cap, it is recommended that you use a genuine Hyundai replacement part. If you open the fuel filler cap during high ambient temperatures, a slight "pressure sound" may be heard. This is normal and not a cause for concern.

DB37A1-A

HOOD RELEASE

1. Pull the release knob to unlatch the hood.
2. Press the safety catch lever up and lift the hood.
3. Hold the hood open with the support rod.

Before closing the hood, return the support rod to its clip to prevent it from rattling. Lower the hood until it is about 1 ft. (30 cm) above the closed position and let it drop. Make sure that it locks into place.

CAUTION:

Make sure that the support rod has been released prior to closing the hood. Always double check to be sure that the hood is firmly latched before driving away. If it is not latched, the hood could fly open while the vehicle is being driven, causing a total loss of visibility, which might result in an accident. The support rod must be inserted completely into the hole provided in the hood whenever you inspect the engine compartment. This will prevent the hood from falling and possibly injuring you. Do not move the vehicle with the hood in the raised position, as vision is obstructed and the hood could fall or be damaged.

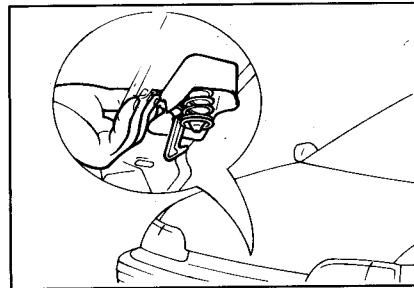
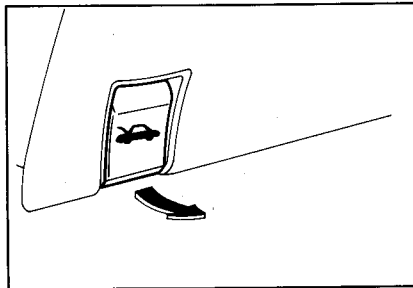
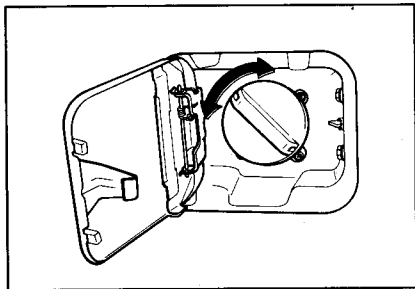

FEATURES OF YOUR HYUNDAI

DB38A1-A

SUN-VISOR

Your Hyundai is equipped with a sun visor to give the driver and front passenger either frontal or side ward shade. The sun visors are fitted on both sides on standard models. To reduce glare or to shut out direct rays of the sun, turn the sun visor down to block the annoyance.

A vanity mirror is provided on the back of the sun visor for the front passenger.

A child restraint label containing useful information can be found on the sun visor as well. (Refer to pages (1-12)-(1-14) for additional information.)

CAUTION:

Do not place the sun visor in such a manner that it obscures visibility of the roadway, traffic or other objects.

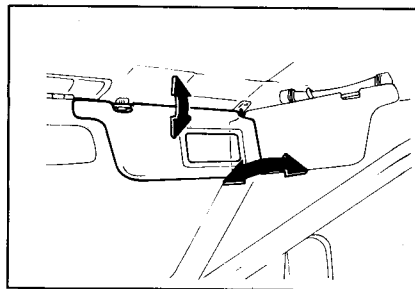

DB39A1-A

STEERING WHEEL TILT LEVER (If installed)

To adjust the steering wheel:

1. Push the lever downward to unlock.
2. Raise or lower the steering wheel to the desired position.
3. After adjustment, securely tighten the lever by pulling upward.

WARNING

Do not attempt to adjust the steering wheel while driving as this may result in loss of control of the vehicle and an accident.

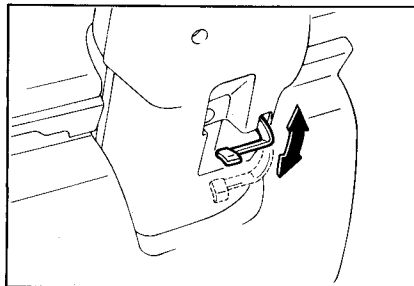

ZB42A1-A

HORN

Press the center hub of the steering wheel to sound the horn.

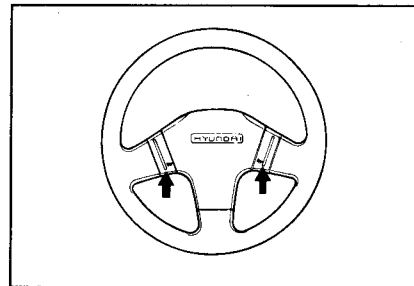

FEATURES OF YOUR HYUNDAI

DB90A1-A

CRUISE CONTROL (If installed)

The cruise control system provides automatic speed control for your comfort when driving on freeways, tollroads, or other noncongested highways.

This is designed to function above approximately 25 mph (40 km/h).

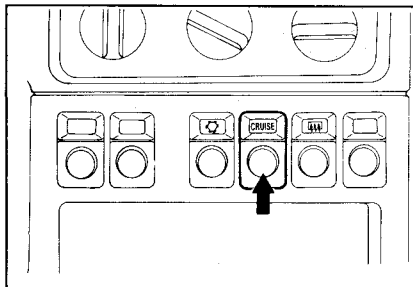

DB90B1-A

To set the cruise speed

1. To operate the cruise control, push the main cruise control switch. This turns the system on. The indicator light in the dash panel will illuminate showing that you can now set the vehicle at the desired speed. Another push will turn the system completely off.
2. Accelerate to desired cruising speed.
3. Push the control switch at the end of the windshield wiper & washer control lever to the "SET (COAST)" direction and release it.
4. Remove your foot from the accelerator pedal and the desired speed will automatically be maintained.
5. To increase speed, depress the accelerator pedal enough for the vehicle to exceed the preset speed. When you remove your foot from the accelerator pedal, the vehicle will return to the previous speed you set.

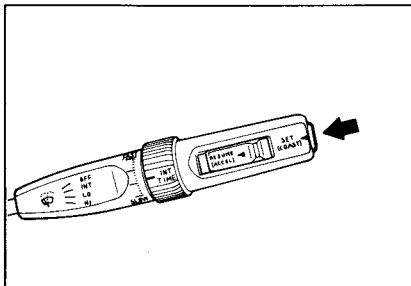

DB90C1-A

To cancel the cruise speed

Do one of the following:

- o Depress the brake pedal.
- o Depress the clutch pedal (manual transaxle).
- o Decrease the vehicle speed lower than memory speed by 12.5 mph (20 km/h).
- o Decrease the vehicle speed approximately to less than 25 mph (40 km/h).
- o Release the main switch.

FEATURES OF YOUR HYUNDAI

DB90D1-A

Resume to the preset speed

The vehicle will automatically resume to the speed set prior to cancellation when you push the control switch "RESUME (ACCEL)" to the left side and release it to return (above 25 mph).

DB90E1-A

To reset at a faster speed

1. Push the control switch "RESUME (ACCEL)" to the left side and hold it.
2. Accelerate to the desired speed and release the control switch. While the control switch is held, the vehicle will gradually gain speed.

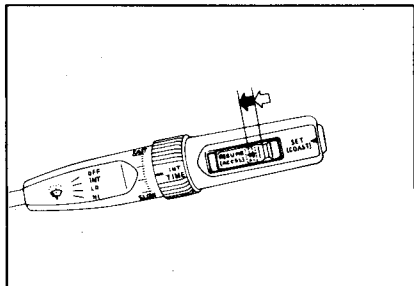

DB90F1-A

To reset at a slower speed

1. Push the control button "SET (COAST)" at the end of the windshield wiper & washer control lever and hold it. The vehicle will decelerate.
2. When the desired speed is obtained, release the control button. While the control switch is pushed, the vehicle speed will gradually decrease.

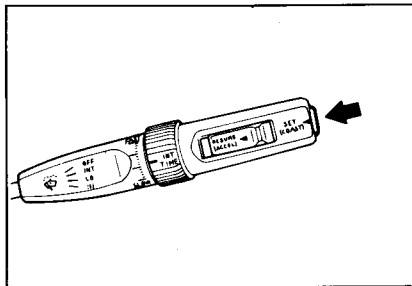

DB90G1-A

NOTE:

- o When the main switch is turned on and you press the set switch or the resume (accel) switch, a buzzer will be activated for 0.2 seconds.
- o Keep the main switch off when not using the cruise control.
- o Do not use the cruise control when it may not be safe to keep the car at a constant speed, for instance, driving in heavy or varying traffic, or on slippery (rainy, icy or snow-covered) or winding roads or over 6% up-hill or down-hill roads.
- o Pay particular attention to the driving conditions whenever using the cruise control system.
- o During cruise control operation with a manual transaxle vehicle, do not shift into neutral without depressing the clutch pedal, since the engine will be over-revved.
If this happens, depress the clutch pedal or release the main switch.

FEATURES OF YOUR HYUNDAI

DB30C1-A

LUGGAGE STRAP

CAUTION:

Loose cargo must be blocked or restrained so that it does not enter the passenger compartment during sudden deceleration.

NOTE:

When the luggage strap is removed, install the luggage strap bolts in their original positions.

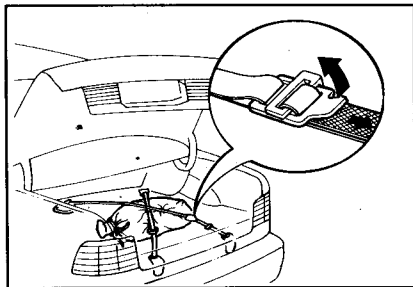

ZB44A1-A

HEATING AND VENTILATION

Rotary Type

This model has four controls for the heating and cooling system. They are.

1. Fan speed control
2. Air flow control
3. Temperature control
4. Air intake control

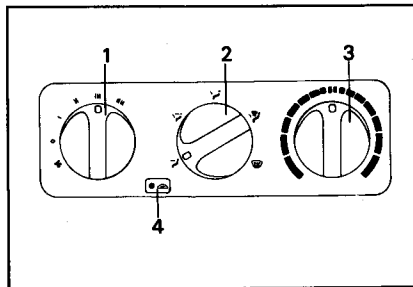

ZB44B1-A

FAN SPEED CONTROL (BLOWER CONTROL)

This is used to turn the blower fan on and off, to select the fan speed

The blower fan speed, and therefore the volume of air delivered from the system, may be controlled manually by setting the blower control between the "I" and "IIII" position.

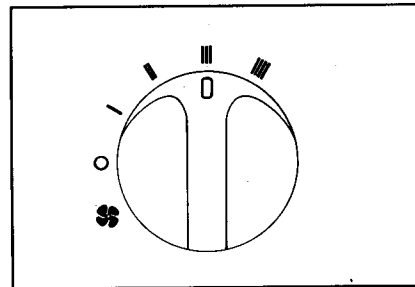

FEATURES OF YOUR HYUNDAI

ZB44C1-A

AIR INTAKE CONTROL

This is used to select fresh outside air or recirculation inside air.

 **Fresh**

 **Recirculation**

With the "fresh" mode selected, air enters the vehicle from outside and is heated or cooled according to the other functions selected.

With the "recirc" mode selected, air from within the passenger compartment is drawn through the heating system and heated or cooled according to the other functions selected.

NOTE:

It should be noted that prolonged operation of the heater in "recirc" mode will give rise to misting of the windshield and side windows and the air within the passenger compartment becoming stale. In addition,

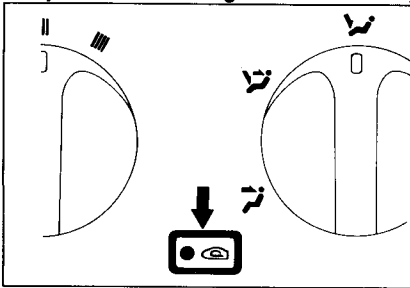

prolonged use of the air conditioner with the "Recirculate" mode selected may result in the air within the passenger compartment becoming excessively dry.

ZB44D1-A

AIR FLOW CONTROL

This is used to direct the flow of air. Air can be directed to the floor, dashboard outlets, or windshield. Five symbols are used to represent Face, Bi-Level, Floor, Floor-Defrost and Defrost air position.

 **Face-Level**

Selecting the "Face" mode will cause air to be discharged through the face level vents.

 **Bi-Level**

Air is discharged through the face vents and the floor vents. This makes it possible to have cooler air from the dashboard vents and warmer air from the floor outlets at the same time.

 **Floor-Level**

Air is discharged through the floor vents.

 **Floor-Defrost Level**

Air is discharged through the windshield defrost vents and the floor vents.

 **Defrost-Level**

Air is discharged through the windshield defrost vents.

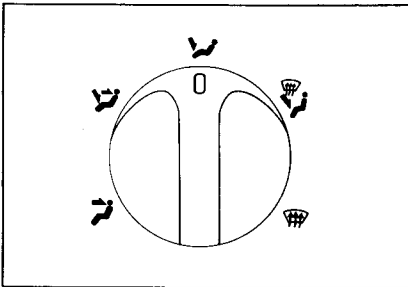

FEATURES OF YOUR HYUNDAI

ZB44E1-A

TEMPERATURE CONTROL

This is used to turn the heater on and off and to select the degree of heating desired.

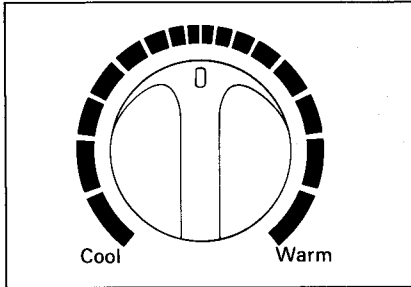

ZB43B1-A

HEATING CONTROLS

For normal heater operation, move the air intake control to the "Fresh" position and the air flow control to "Floor".

For faster heating, the air intake control should be in the "Recirc" position.

If the windows fog up, move the air flow control to the "Def"(defroster) position and the air intake control to "Fresh".

For maximum heat, move the temperature control to "Warm".

ZB43C1-A

BI-LEVEL HEATING

Your Hyundai is equipped with bi-level heating controls. This makes it possible to have cooler air from the dashboard vents and warmer air from the floor outlets at the same time. To use this feature:

- o Set the air intake control to "Fresh".
- o Set the air flow control at the "Bi-Level" position.
- o Set the temperature control between "Cool" and "Warm".

ZB43D1-A

VENTILATION

To operate the ventilation system:

- o Set the air intake control on "Fresh".
- o To direct all intake air to the dashboard vents, set the airflow control to "Face".
- o Adjust the fan speed control to the desired speed.
- o Set the temperature control between "Cool" and "Warm".

FEATURES OF YOUR HYUNDAI

DB43E1-A

CENTER VENTILATOR

The center ventilators are located in the middle of the dashboard.

To change the direction of the airflow, turn the four control knobs as desired.

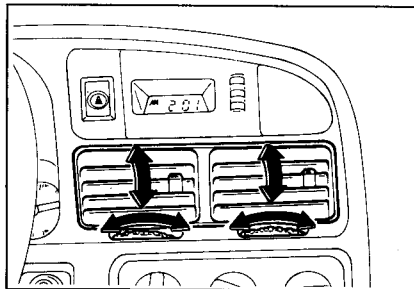

DB43F1-A

SIDE VENTILATOR

The side ventilators are located on each side of the dash board.

The side vent knobs control the amount of outside air entering the vehicle through the side vents. These vents can also be closed, so no air enters through the side vents. To change the direction of the air flow, turn the two control knobs as desired.

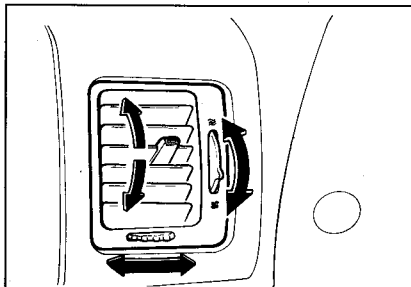

DB43G1-A

DEFROSTING/DEFOGGING

To use the heating/ventilation system to defrost or defog the windshield:

- o Set the air intake control (4) to the "Fresh" position.
- o Set the air distribution control (2) to the "Def" position.
- o Set the temperature control (3) to a comfortably warm position.
- o Set the fan speed control (1) to position III or IIII.
- o If vehicle is so equipped, turn on the A/C for increased defogging action.

NOTE:

In high humidity areas the A/C can be used with the air intake in the "Recirc" position for increased defogging action.

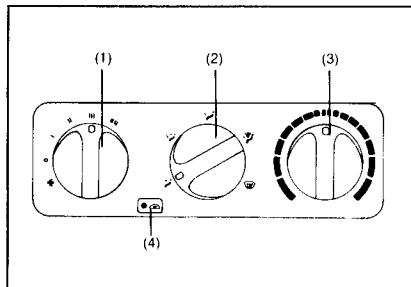

FEATURES OF YOUR HYUNDAI

ZB43H1-A

Operation Tips

- o To keep dust or unpleasant fumes from entering the car through the ventilation system, temporarily set the air intake control at "Recirc". Be sure to return the control to "Fresh" when the irritation has passed to keep fresh air in the vehicle. This will help keep the driver alert and comfortable.
- o Air for the heating/cooling system is drawn in through the grilles just ahead of the windshield. Care should be taken that these are not blocked by leaves, snow, ice or other obstructions.

ZB45A1-A

AIR CONDITIONER SWITCH (If Installed)

The air conditioner is turned on by pushing the button.

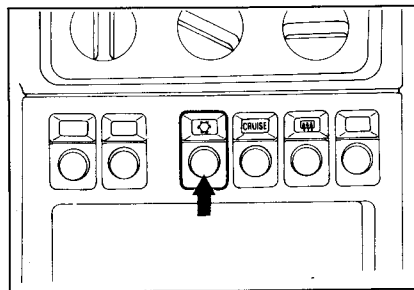

ZB45B1-A

AIR CONDITIONING OPERATION (If Installed)

COOLING

To use the air conditioner to cool interior:

- o Set the side vent control to "OFF", to shut off outside air entry.
- o Turn on the fan control switch.
- o Turn on the air conditioner switch by pushing in on the switch. The air conditioner indicator light should come on at the same time.
- o Set the air intake control to "Fresh".
- o Set the temperature control to "Cool". ("Cool" provides maximum cooling. The temperature may be moderated by moving the control toward "Warm".)
- o Adjust the fan control to the desired speed. For greater cooling, turn the fan control to

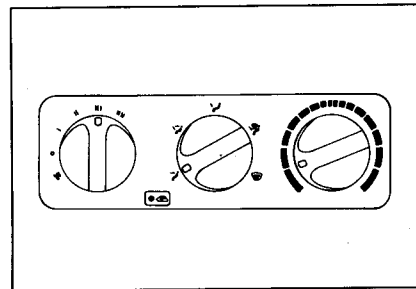

FEATURES OF YOUR HYUNDAI

one of the higher speeds or temporarily select the "Recirc" position on the air intake control.

DB45C1-A

DE-HUMIDIFIED HEATING

For dehumidified heating:

- o Turn on the fan control switch.
- o Turn on the air conditioner switch.
The air conditioner indicator light should come on at the same time.
- o Set the air intake control to "Fresh".
- o Set the air flow control to "Face".
- o Adjust the fan control to the desired speed.
- o For more rapid action, set the fan at one of the higher speeds.
- o Adjust the temperature control to provide the desired amount of warmth.

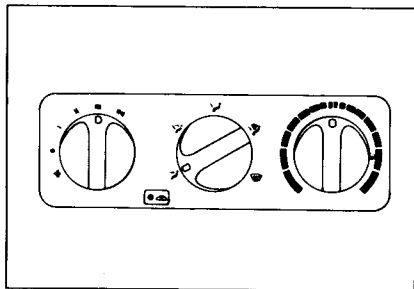

1-40

DB45D1-A

Operation Tips

- o If the interior of the car is hot when you first get in, open the windows for a few minutes to expel the hot air.
- o When you are using the air conditioning system, keep all windows closed to keep hot air out.
- o When moving slowly, as in heavy traffic, shift to a lower gear. This increases engine speed, which in turn increases the speed of the air conditioning compressor.
- o On steep grades, turn the air conditioner off to avoid the possibility of the engine overheating.
- o During winter months or in periods when the air conditioner is not used regularly, turn on the air conditioner switch occasionally for a few minutes.

This will help circulate the lubricants and keep your system in peak operating condition.

ZB50A1-A

STEREO SOUND SYSTEM

How Car Audio Works

AM and FM radio signals are broadcast from transmitter towers located around your city. They are intercepted by the radio antenna on your car. This signal is then received by the radio and sent to your car speakers. When a strong radio signal has reached your vehicle, the precise engineering of your audio system ensures high quality reproduction. However, in some cases the signal coming to your vehicle is not strong and clear. This can be due to factors such as the distance from the radio station, closeness of other strong radio stations or the presence of buildings, bridges or other large obstructions in the area.

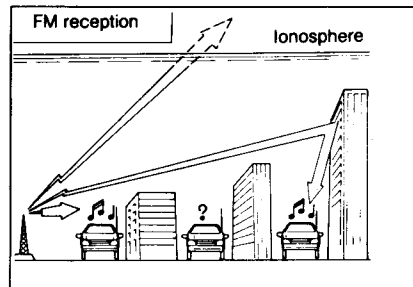

FEATURES OF YOUR HYUNDAI

AM signal reception is usually better than FM reception. This is because AM radio waves are transmitted at low frequency. These long, low frequency radio waves can follow the curvature of the earth rather than travelling straight out into the atmosphere. In addition, they curve around obstructions so that they can provide better signal coverage. Because of this, clear AM broadcasts can be received at greater distances than FM broadcasts.

FM broadcasts are transmitted at high frequency and do not bend to follow the earth's surface. Because of this, FM broadcasts generally begin to fade at short distances from the station. Also, FM signals are easily affected by buildings, mountains, or other obstructions. These can result in certain listening conditions which might lead you to believe a problem exists with your radio. The following conditions are normal and do not indicate radio trouble:

- o Fading - As your car moves away from the radio station, the signal will weaken and sound will begin to fade. When this occurs, we suggest that you select another stronger station.
- o Flutter/Static - Weak FM signals or large obstructions between the transmitter and your radio can disturb the signal causing static or fluttering noises to occur. Reducing the treble level may lessen this effect until the disturbance clears.

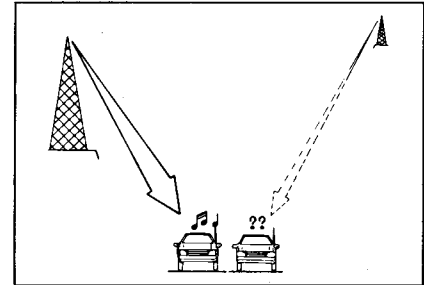
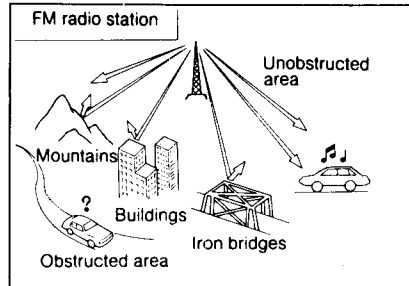
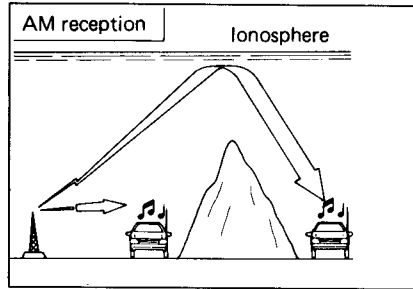

FEATURES OF YOUR HYUNDAI

- o Station Swapping - As an FM signal weakens, another more powerful signal near the same frequency may begin to appear. This is because your radio is designed to lock onto the clearest signal. If this occurs, select another station with a stronger signal.
- o Multi-Path Cancellation - Radio signals being received from several directions can cause distortion or fluttering. This can be caused by a direct and a reflected signal from the same station, or by signals from two stations with close frequencies. If this occurs, select another station until the condition has passed.

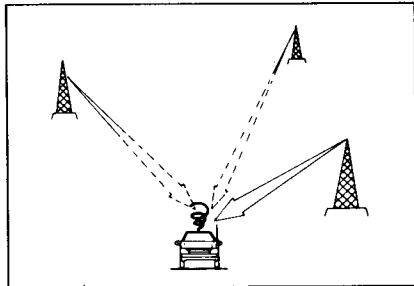

FEATURES OF YOUR HYUNDAI

ZB50B1-A

ANTI-THEFT SYSTEM (If Installed)

Setting the Anti-Theft system

To deter theft of your radio, the system is designed so that the radio unit becomes inoperable if it is stolen from the vehicle or the identification number is not input.

1. Make sure that the power switch is on, with the ignition switch is in "ACC" position. The "COdE" will be displayed on LCD.

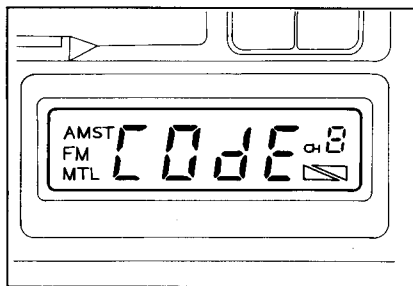

2. Input your identification number by pressing the "PRESET" buttons in sequence. If your number is 3456, press the 3 button for the first digit, the 4 button for the second digit, the 5 button for the third digit and the 6 button for the last digit.

NOTE:

The identification number is on the "USER CARD" that came with your Hyundai. This "USER CARD" should not be left with the radio, but in a safe place, not in the vehicle. The identification number should also be recorded in a secure place. If you need an additional "USER CARD" or if you should lose it, your authorized Hyundai dealer can make a new one.

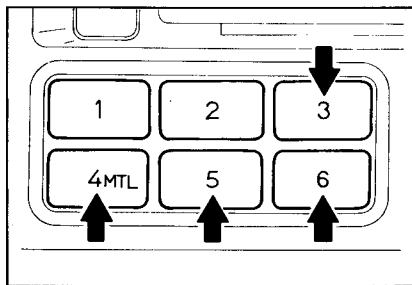

Canceling the Incorrect Identification No.

If the incorrect identification No. is input, the Anti-Theft system will activate and the radio unit will become inoperable. To correct this, press and hold the "BAND" button for 3 seconds or more, until the incorrect number on LCD disappears and "COdE" is displayed again.

NOTE:

If the incorrect identification number is input 3 times, it will not be possible to cancel the incorrect identification number.

Thereafter cancellation cannot be made until one hour elapses.

NOTE:

Anti-Theft system will be activated if the electrical power source is ever disconnected from the radio unit. If this happens, like the battery being discharged or disconnected, see "Setting the Anti-Theft system."

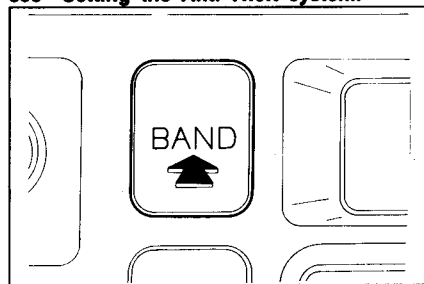

FEATURES OF YOUR HYUNDAI

Anti-Theft Indicator

The Anti-Theft indicator On/Off Control is available with the ignition key in the Off position. With the Power Switch in the Off position, press the BAND button to cancel the Indicator Blinking Mode, and simply push the BAND button again to re-activate the Indicator Blinking Mode again.

NOTE:

If the radio will not be used for long time, the Anti-Theft Indicator Blinking Mode should be set to the Off position to save vehicle battery power.

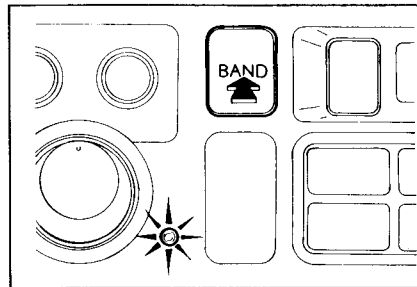

FEATURES OF YOUR HYUNDAI

ZB55A1-A

STEREO RADIO AND CASSETTE TAPE PLAYER OPERATION (H-510) (If Installed)

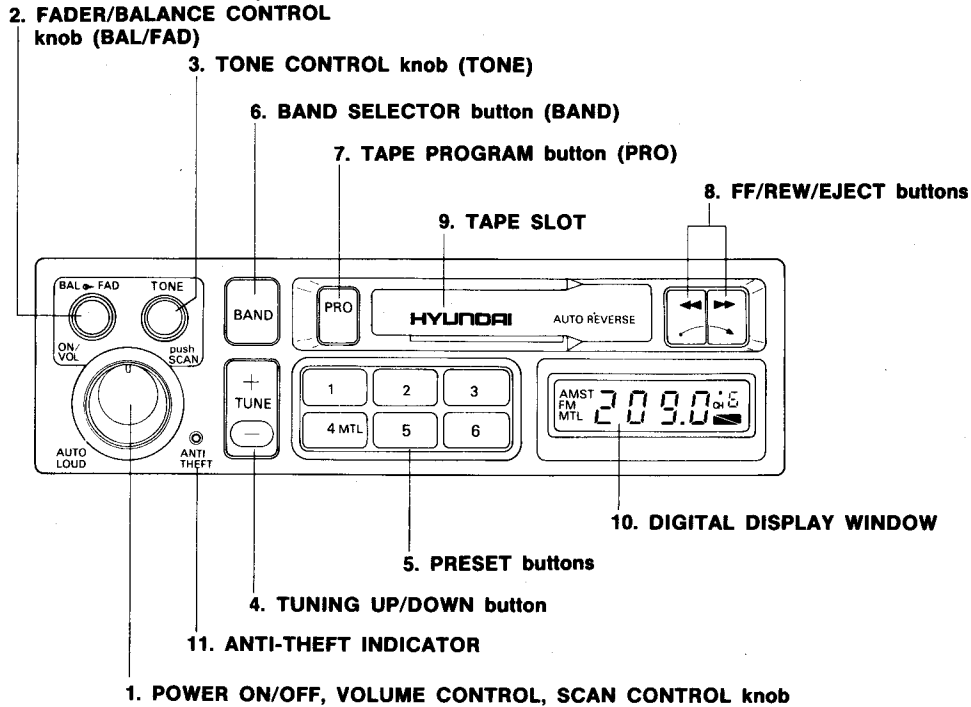

FEATURES OF YOUR HYUNDAI

ZB55B1-A

1. **POWER ON/OFF, VOLUME CONTROL, SCAN CONTROL knob**

Turn knob (On/Off switch) to turn on power, then adjust volume as desired.

SCAN TUNING

Press the POWER ON/OFF button and scan tuning will be activated with the frequency flashing in the display. Tuned frequency will increase, stopping for 5 seconds at each station. Press the button again, to hold desired station.

2. **BAL (Balance Control) knob**

Pop-up control knob with one push. Turn control knob clockwise to emphasize right speaker sound. (Left speaker sound will be attenuated.)

When control knob is turned counterclockwise, left speaker sound will be emphasized. (Right speaker sound will be attenuated.)

FAD (Fader Control) knob

Further pull-lock position of popped-up knob. Turn control knob clockwise to emphasize rear speaker sound. (Front speaker sound will be attenuated.)

When control knob is turned counterclockwise, front speaker sound will be emphasized. (Rear speaker sound will be attenuated.)

3. **TONE (Control) knob**

Pop-up control knob with one push. Turn control knob clockwise to emphasize high audio-frequency and counterclockwise to attenuate high audio-frequency.

4. **TUNING UP/DOWN button**

Frequency on LCD increases when "+" is pressed and decreases when "-" is pressed.

Frequency will change by 1 step each time the button is pressed.

SEEK Mode:

Keep the "+" or "-" pressed on the tune button for more than 0.5 seconds to actuate the SEEK function.

5. **PRESET buttons**

Pressing a preset button for more than 2 seconds will allow the radio to memorize the station displayed in the frequency display.

During this function, the radio will go into a MUTE mode until the station is memorized. When in the tape mode, Preset No.4 button can be used for the MTL (Metal) function On/Off switch.

6. **BAND (Switch) button**

Pressing the BAND switch changes between AM and FM bands.

7. **TAPE PROGRAM button**

This allows you to play the reverse side of the tape by merely depressing the program button. An arrow will appear in the display to show tape direction.

8. **FF/REW/EJECT buttons**

When you press the button whose arrow is in the same direction as the tape play arrow in the display the tape will advance at high speed.

When you press the button whose arrow is in the opposite direction to the tape play arrow in the display the tape will rewind at high speed. To stop FF or REW action, press the opposite button or press the tape program button. But if the tape program button is pressed, it will also reverse the tape play direction. To eject the tape, press the FF and REW buttons simultaneously.

FEATURES OF YOUR HYUNDAI

NOTE:

- o To assure proper operation of the unit, keep the vehicle interior temperature within a normal range by using the vehicle's air conditioner or heater.
- o When replacing the fuse, replace it with a fuse having the correct capacity.
- o The preset station frequencies are all erased when the car battery is disconnected. Therefore, all data will have to be set again if this should occur.
- o Do not add any oil to the rotating parts.
- o Keep magnets, screwdrivers and other metallic objects away from the tape mechanism and head.
- o This equipment is designed to be used only in a 12 volt DC battery system with negative ground.
- o This unit is made of precision parts. Do not attempt to disassemble or adjust any parts.
- o When driving your vehicle, be sure to keep the volume of the unit set low enough to allow you to hear sounds coming from the outside.
- o Do not expose this equipment (including the speakers and tape) to water or excessive moisture.

FEATURES OF YOUR HYUNDAI

ZB56A1-A

STEREO RADIO OPERATION (H-550) (If installed)

2. FADER/BALANCE CONTROL knob

3. BASS/TREBLE CONTROL knob

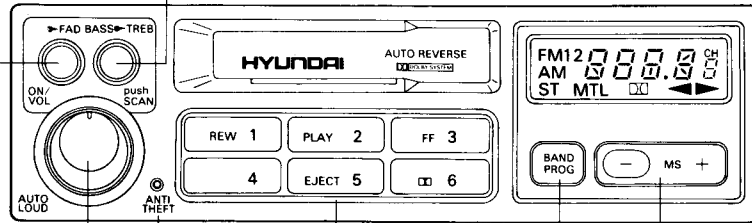

6. TUNING UP/DOWN button

5. BAND SELECTOR button

4. PRESET button

7. ANTI-THEFT INDICATOR

1. POWER ON/OFF, VOLUME, SCAN CONTROL knob

FEATURES OF YOUR HYUNDAI

ZB56B1-A

1. POWER ON/OFF, VOLUME CONTROL, SCAN CONTROL knob

Turn knob (On/Off switch) to turn on power, then adjust volume as desired.

SCAN TUNING

Press the POWER ON/OFF button and scan tuning will be activated with the frequency flashing in the display. Tuned frequency will increase, stopping for 5 seconds at each station. Press the button again, to hold desired station.

2. BAL (Balance Control) knob

Pop-up control knob with one push. Turn control knob clockwise to emphasize right speaker sound. (Left speaker sound will be attenuated.)

When control knob is turned counterclockwise, left speaker sound will be emphasized. (Right speaker sound will be attenuated.)

FAD (Fader Control) knob

Pull popped-up FAD/BAL button out one more click. Turn control knob clockwise to emphasize rear speaker sound. (Front speaker sound will be attenuated.)

When control knob is turned counterclockwise, front speaker sound will be emphasized. Rear speaker sound will be attenuated.)

3. BASS (Control) knob

Pop-up control knob with one push. Turn control knob clockwise to emphasize bass and counterclockwise to reduce bass.

TREB (Control) knob

Pull popped-up BASS/TREB button out one more click. Turn control knob clockwise to emphasize treble and counterclockwise to attenuate treble.

4. PRESET buttons

Pressing a preset for more than 2 seconds will allow the radio to memorize the station displayed in the frequency. During this function, the radio will go into a mute mode until the station is memorized.

5. BAND (Switch) button

Pressing the BAND switch changes between AM and FM1, FM2 bands.

6. TUNING UP/DOWN button

Frequency on LCD increases when "+" is pressed and decreases when "-" is pressed. Frequency will change by 1 step each time the button is pressed.

SEEK Mode :

Keep the "+" or "-" pressed on the tune button for more than 0.5 seconds to actuate the SEEK function.

FEATURES OF YOUR HYUNDAI

ZB56C1-A

CASSETTE TAPE PLAYER OPERATION (H-550) (If installed)

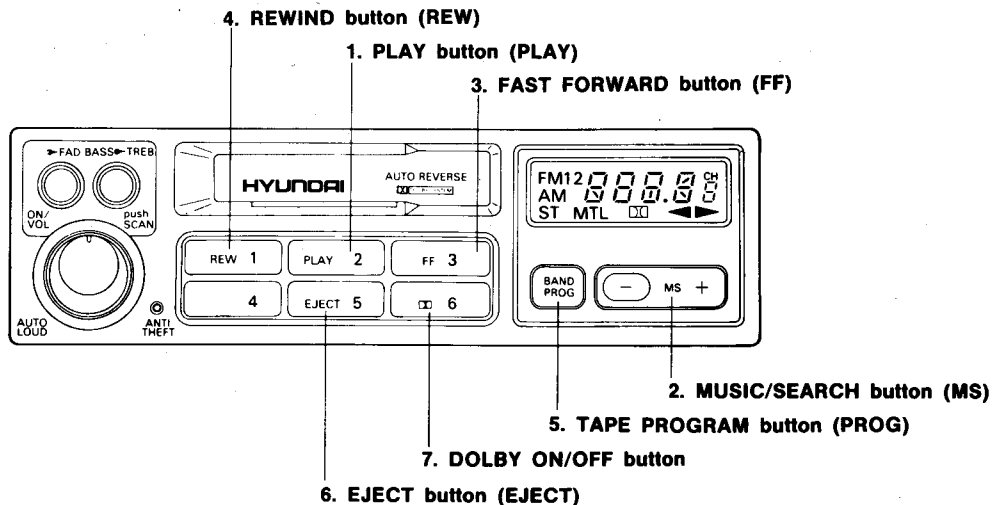

FEATURES OF YOUR HYUNDAI

ZB56D1-A

1. PLAY button

Press for tape PLAY. ("PLAY" mark will be lit on LCD.) Pressing this button while the tape is fast forwarding or rewinding, will keep the play mode operational.

2. MUSIC/SEARCH button (MS)

When the "+" side of the MS button is pressed, the tape will fast forward to the start of the next music selection. When the "-" side of the MS button is pressed, the tape will rewind to the start of the current music selection. During the MS (SEEK) mode, the LCD will indicate the SEEK mode.

3. FF button

Press for FF button (tape Fast Forward). ("FF" mark will be lit on LCD.) Press FF again to cancel FF mode, then tape will automatically return to the PLAY mode.

4. REW button

Press for REW button (tape Rewind). ("REW" mark will be lit on LCD.) Press REW button again to cancel REW mode, then tape will automatically return to the PLAY mode.

5. TAPE PROGRAM button

Press for tape running direction change.

6. EJECT button

Press to eject tape.

7. DOLBY On/Off Switch button

Press for, DOLBY switch on/off (When DOLBY on, "DOLBY" mark will be lit on LCD.)

REMARKS:

1. Tape Head Cleaning Information

When 30 hours of tape play have been accumulated, the unit will automatically go into the MUTE condition for 10 seconds and marks of "CLn" and "PLAY" will be lit alternately on LCD during the MUTE condition.

2. Auto-Metal Function:

When metal tape is used, Metal Equalization will be automatically actuated for PLAY. ("MTL" mark will be lit on LCD.)

3. When cassette tape is inserted, "PLAY" mark will be lit on LCD.

NOTE:

- o To assure proper operation of the unit, keep the vehicle interior temperature within a normal range by using the vehicle's air conditioner or heater.
- o When replacing the fuse, replace it with a fuse having the correct capacity.
- o The preset station frequencies are all erased when the car battery is disconnected. Therefore, all data will have to be set again if this should occur.
- o Do not add any oil to the rotating parts.
- o Keep magnets, screwdrivers and other metallic objects away from the tape mechanism and head.
- o This equipment is designed to be used only in a 12 volt DC battery system with negative ground.
- o This unit is made of precision parts. Do not attempt to disassemble or adjust any parts.
- o When driving your vehicle, be sure to keep the volume of the unit set low enough to allow you to hear sounds coming from the outside.
- o Do not expose this equipment (including the speakers and tape) to water or excessive moisture.

FEATURES OF YOUR HYUNDAI

YB58A1-A

STEREO RADIO OPERATION (H-565) (If installed)

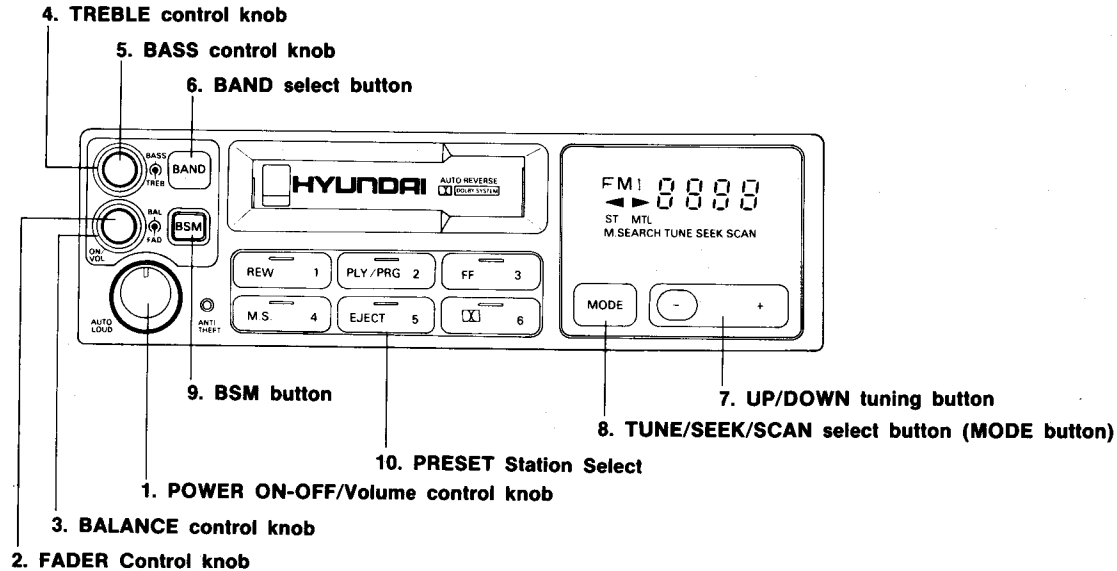

FEATURES OF YOUR HYUNDAI

YB58B1-A

1. POWER ON-OFF/VOLUME CONTROL KNOB

The radio unit may be operated when the ignition key is in the "ACC" or "ON" position. Rotate the knob clockwise to switch the radio unit on, and to increase the volume. Turn the knob counterclockwise to reduce the volume, and to switch the radio unit off.

2. FADER control (FAD)

Press to pop the knob out and rotate the sleeve to adjust the sound levels between the front and rear speakers.

3. BALANCE control (BAL)

Press to pop the knob out and turn it clockwise or counter clockwise until sound from the left and right speakers is about equal from your listening position.

4. TREBLE control (TREB)

Press to pop the knob out and turn to the left or right for the desired treble tone.

5. BASS control

Press to pop the knob out and turn to the left or right for the desired bass tone.

6. BAND selector

Pressing the BAND button changes the AM, FM1 and FM2 bands. The mode selected is displayed on LCD.

7. UP/DOWN TUNING button

Press the button to select a higher or lower station frequency.

8. TUNE/SEEK/SCAN SELECT button (MODE button)

When this button is pressed in the RADIO mode, the current mode is switched over to the CYCLIC mode.

TUNE— SEEK— SCAN

o TUNE (Manual) Selection

- (1) Select the TUNE with the MODE button.
- (2) The moment the tuning button is pressed for 0.5 sec. or less, the frequency moves one step up or down.
- (3) With the button held down, the stop signal (broadcasting radio wave) is ignored, and channel selection continues.

o SEEK Operation (Automatic Channel Selection)

- (1) Select the SEEK mode using the MODE button.
- (2) The moment the tuning button is pressed, the SEEK UP or DOWN starts.
- (3) The stop signal remains effective even with the button held down.
- (4) The unit automatically tunes to the next higher or lower frequency and locks on to that station.

o SCAN

- (1) Select the SCAN mode with the MODE button.
- (2) Press the TUNING button for more than two seconds and scan tuning will be activated with the frequency flashing in the display. Tuned frequency will increase or decrease, stopping for 5 seconds at each station. Press the TUNING button again, to hold desired station.

FEATURES OF YOUR HYUNDAI

9. BEST STATION MEMORY button (BSM)

- o When the BSM button is pressed for two seconds or longer, the preceding memory is all cleared, and six channels with the highest field intensity are selected and kept in memory of the preset key in the sequence of the preset key in the sequence of frequencies.
- o After the auto memory operation, CH1 is selected and received.
- o If memory cannot be made, either FM0 or AM0 is displayed.
- o The auto memory operates on each band, namely, AM, FM1 and FM2.

10. PRESET STATION SELECT

Six (6) stations for AM, FM1 and FM2 respectively can be preset in the electronic memory circuit on this unit.

HOW TO PRESET STATIONS

Six AM and twelve FM stations may be programmed into the memory of the radio. Then, by simply pressing the band select button and/or one of the six station select buttons, you may recall any of these stations instantly. To program the stations, follow these steps:

- o Press band selector to set the band for AM, FM1 and FM2.
- o Select the desired station to be stored by seek, scan or manual tuning.
- o Determine the preset station select button you wish to use to access that station.
- o Press the station select button for more than two seconds. A select button indicator will show in the display indicating which select button you have depressed. The frequency display will flash after it has been stored into the memory.
You should then release the button, and proceed to program the next desired station. A total of 18 stations can be programmed by selecting one AM and two FM stations per button.
- o When completed, any preset station may be recalled by selecting AM, FM1 or FM2 band and the appropriate Station Button.

FEATURES OF YOUR HYUNDAI

YB58C1-A

CASSETTE TAPE PLAYER OPERATION (H565) (If installed)

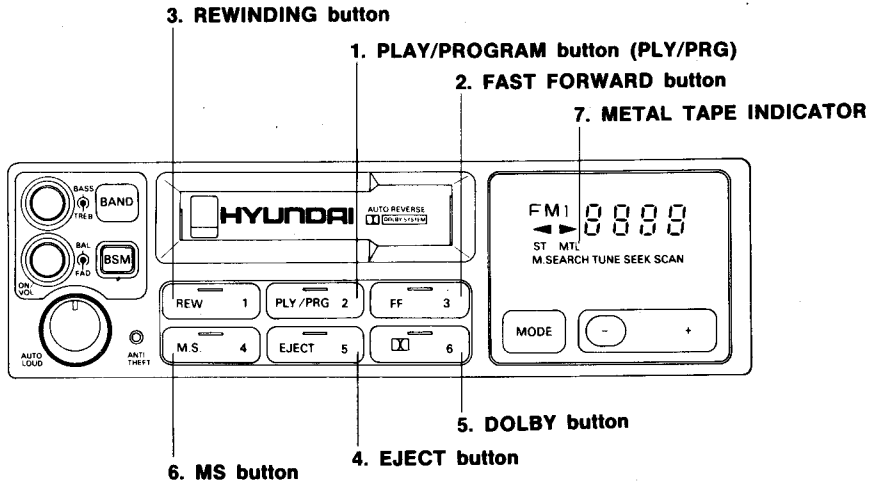

FEATURES OF YOUR HYUNDAI

YB58D1-A

1. PLAY/PROGRAM button (PLY/PRG)

The play starts when PLY/PRG button is pressed during FF or REW. The playback side is reversed to start the play when the PLY/PRG button is pressed during PLAY.

2. FAST FORWARD button (FF)

- o The FF (fast forward tape winding) starts when the FF button is pressed during the PLAY or REW.
- o When the tape end occurs during FF, the PROG is reversed, to start the play.
- o The play starts when the PLY/PRG button is pressed during FF.

3. REWINDING button

- o The REW (rewinding) starts when the REW button is pressed during PLAY or FF.
- o When the tape end occurs during REW, the play starts.
- o The play starts when the PLY/PRG button is pressed during REW.

4. EJECT button

- o When the EJECT button is pressed with the cassette loaded, the cassette is ejected.
- o When the EJECT button is pressed during the FF/REW, the cassette is ejected.

5. DOLBY button

- o Whenever the DOLBY button is pressed in the TAPE mode, DOLBY Noise Reduction will be turned ON or OFF.
- o DOLBY ON and OFF conditions are stored in memory unless the battery is disconnected.

NOTE:

Reduction will be turned ON or OFF

6. MS (Music Sensor) button

Press the button to find the starting point of each program in a prerecorded music tape. The quiet space between programs (must have at least a 3 sec. gap) can be sensed by the music sensor (MS) circuit. If MS is not required, press the MS button again.

NOTE:

Most commercially available music cassette tapes are suitable for the MS system.

How to operate the MS:

Press the MS button and the red light on the button will light up.

Forward MS:

Pressing the tuning button(+) will play the beginning of the next music segment.

Rewind MS:

Pressing the tuning button(-) will start replay at the beginning of the music just listened to.

Tapes not suitable for MS operation:

The MS circuitry may not function properly for tapes described below, causing tapes to stop midway through a program or to overrun the space between programs.

1. Tapes which contain intermittent sound such as conversations, lectures, news, or music that includes many silent or mute passages.
2. Tapes which have a very short time interval between recorded programs.
3. Tapes which have a high level of noise or hum between programs.
4. Tapes which have a particularly low recorded level.

FEATURES OF YOUR HYUNDAI

NOTE:

- o To assure proper operation of the unit, keep the vehicle interior temperature within a normal range by using the vehicle's air conditioner or heater.
- o When replacing the fuse, replace it with a fuse having the correct capacity.
- o The preset station frequencies are all erased when the car battery is disconnected. Therefore, all data will have to be set again if this should occur.
- o Do not add any oil to the rotating parts.
- o Keep magnets, screwdrivers and other metallic objects away from the tape mechanism and head.
- o This equipment is designed to be used only in a 12 volt DC battery system with negative ground.
- o This unit is made of precision parts. Do not attempt to disassemble or adjust any parts.
- o When driving your vehicle, be sure to keep the volume of the unit set low enough to allow you to hear sounds coming from the outside.
- o Do not expose this equipment (including the speakers and tape) to water or excessive moisture.

FEATURES OF YOUR HYUNDAI

YB60A1-A

COMPACT DISC PLAYER OPERATION (CD-10) (If Installed)

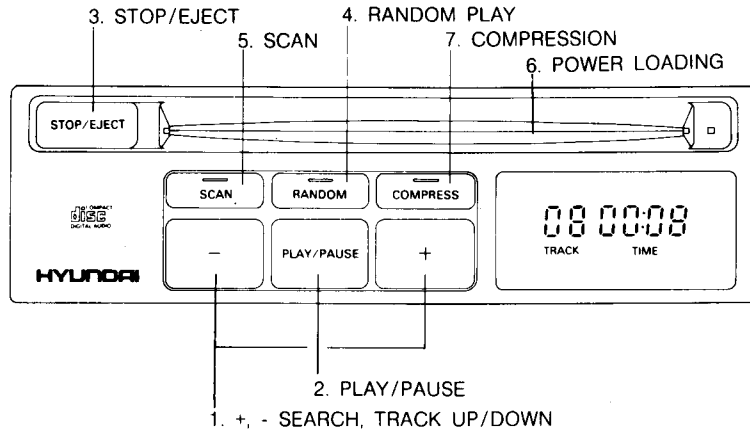

FEATURES OF YOUR HYUNDAI

YB60B1-A

1. +, - SEARCH, TRACK UP/DOWN

- 1) Press the button once to make the Track No. search UP/DOWN.
- 2) If you press the button over 0.5 second, you can get FWD/RWD operation.

2. PLAY/PAUSE

- 1) If a disc is already loaded and in Stop or Pause mode, press the PLAY/PAUSE button to start playback.
- 2) While the disc is playing, press the PLAY/PAUSE button to pause CD playback.
- 3) A disc can be loaded without changing mode and will remain unchanged while pressing the MUTE button to eject the disc.
- 4) While a disc is in the PAUSE mode, PAUSE will illuminate on the display.

3. STOP/EJECT

- 1) Press the STOP/EJECT button once to stop CD playback and to change to Radio-/Cassette operation.
- 2) Press the STOP/EJECT button twice to eject the disc.

4. RANDOM PLAY

- 1) A disc will be played back in a random sequence.
- 2) Press the RANDOM button to play back in a random sequence while the disc is in play.
- 3) While the disc is in PAUSE mode, press RANDOM button and then PLAY/PAUSE button to play back in a random sequence.
- 4) After all the tracks are played back, the unit will play back again in a random sequence. The same track will not be played back twice in one cycle of the disc.
- 5) RANDOM PLAY indicator will illuminate.

5. SCAN

- 1) Press this SCAN button to play back the first 10 seconds of a track.
- 2) Scan play will be repeated until you release SCAN button.

6. POWER LOADING

- 1) Power loading system will pull a disc in and guide it into the play position.
- 2) At the ejected position, a disc can be loaded into disc slot by pressing PLAY/PAUSE button or pressing the disc edge lightly to move it forward.
- 3) When a disc is loaded by pressing PLAY/PAUSE button, it will automatically begin playback.
- 4) If the disc remains at the ejected position more than 15 seconds, the disc will automatically reload into the mechanism.

7. COMPRESSION

Press the COMPRESSION button to activate the COMPRESSION function. Press the COMPRESSION button again to deactivate.

This feature allows the unit to narrow the dynamic range (difference between big and small sound) to decrease rapid change in sound difference when you change from tape/radio mode to disc mode.

FEATURES OF YOUR HYUNDAI

YB60C1-A

Care of DISC

Proper Handling

Handle your disc as shown. Do not drop the disc. Hold the disc so you will not leave fingerprints on the surface. If the surface is scratched, it may cause the pickup to skip signal tracks. Do not affix tape, paper, or gummed labels on the disc. Do not write on the disc.

Damaged Disc

Do not attempt to play damaged, warped or cracked discs. It could severely damage the playback mechanism.

Storage

When not in use, place your discs in their individual case and store them in a cool place away from the sun, heat, and dust.

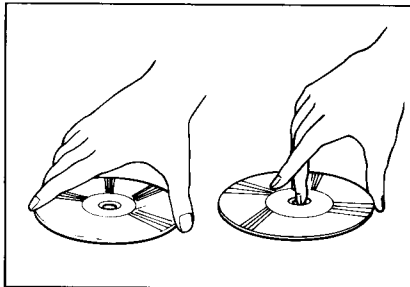

Do not grip or pull out the disc with your hand while the disc is being pulled into the unit by Self Loading mechanism.

Do not pull the unit from the dash immediately after a disc is inserted or the Eject Switch has been pressed. If the unit is pulled out before an operation is completed, the disc will be unstable in the unit and may be damaged.

Do not attempt to insert a disc into the unit when the unit is out of the dash or the power is off.

Keep Your Discs Clean

Fingerprints, dust, or soil on the surface could cause the pickup to skip signal tracks. Wipe the surface clean with a clean soft cloth. If the surface is heavily soiled, dampen a clean soft cloth in a solution of mild neutral detergent to wipe it clean. See drawing.

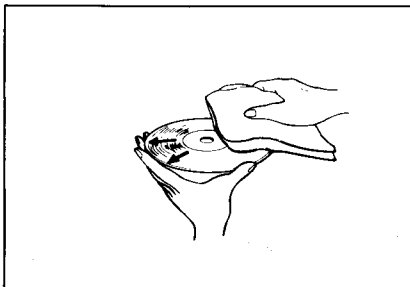

DB54C1-A

Care of Cassette Tapes

Proper care of your cassette tapes will extend the tape life and increase your listening enjoyment. Always protect your tapes and cassette cases from direct sunlight, severe cold and dusty conditions. When not in use, cassettes should always be stored in the protective cassette case in which they were originally supplied. When the vehicle is very hot or cold, allow the interior temperature to become more comfortable before listening to your cassettes.

- o Never leave a cassette inserted in the player when not being played. This could damage the tape player unit and the cassette tape.
- o We strongly recommend against the use of tapes longer than C-60 (60 minutes total). Tapes such as C-120 or C-180 are very thin and do not perform as well in the

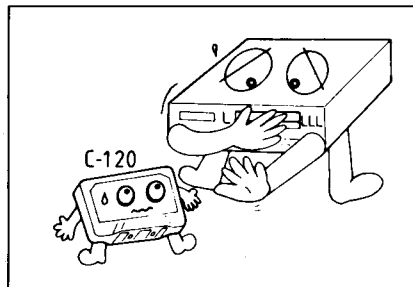

FEATURES OF YOUR HYUNDAI

automotive environment.

- o Be sure that the cassette label is not loose or peeling off or tape ejection may be difficult.
- o Never touch or soil the actual audio tape surfaces.
- o Keep all magnetized objects, such as electric motors, speakers or transformers away from your cassette tapes and tape player unit.
- o Store cassettes in a cool, dry place with the open side facing down to prevent dust from entering the cassette body.
- o Avoid repeated fast reverse usage to replay one given tune or tape section. This can cause poor tape winding to occur, and eventually cause excessive internal drag and poor audio quality in the cassette. If this occurs, it can sometimes be corrected

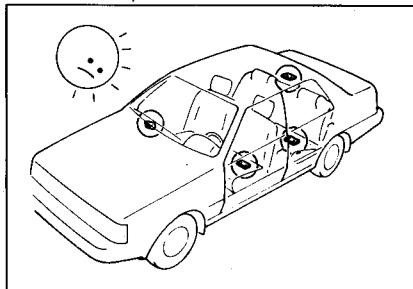

by fast winding the tape from end to end several times. If this does not correct the problem, do not continue to use the tape in your vehicle.

- o The playback head, capstan and pinch rollers will develop a coating of tape residue that can result in deterioration of sound quality, such as a wavering sound. They should be cleaned monthly using a commercially available head cleaning tape or special solution available from audio speciality shops. Follow the supplier's directions carefully and never oil any part of the tape player unit.
- o Always be sure that the tape is tightly wound on its reel before inserting in the player. Rotate a pencil in the drive sprockets to wind up any slack.

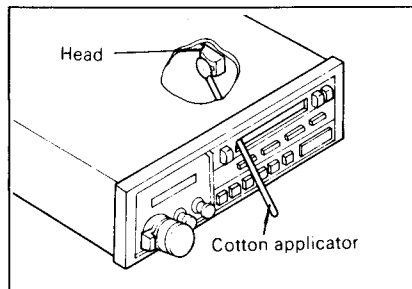

DB55A1-A

ANTENNA

Your car uses a manual stainless steel antenna to receive both AM and FM broadcast signals. Pull up the antenna using your fingers, as shown in the drawing.

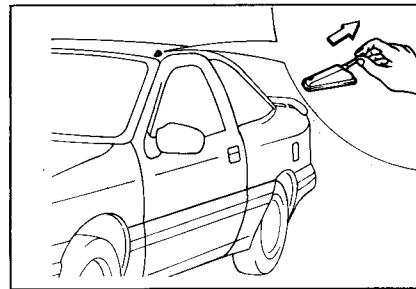

FEATURES OF YOUR HYUNDAI

NOTE:

Before entering an automatic car wash or a place with a low height clearance, be sure that the antenna is fully retracted.

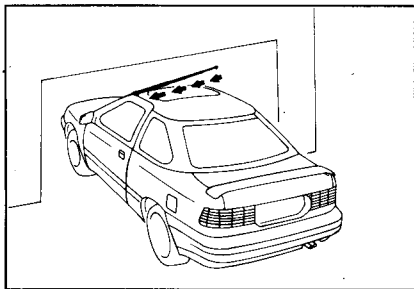

DC01A1-A

2. BEHIND THE WHEEL

Driving Your Hyundai

DRIVING YOUR HYUNDAI

DC02A1-A

WARNING

WARNING: ENGINE EXHAUST CAN BE DANGEROUS!

Engine exhaust fumes can be extremely dangerous. If, at any time, you smell exhaust fumes inside the vehicle, open the windows immediately.

o Do not inhale exhaust fumes.

Exhaust fumes contain carbon monoxide, a colorless, odorless gas that can cause unconsciousness and death by asphyxiation.

o Be sure the exhaust system does not leak.

The exhaust system should be checked whenever the vehicle is raised to change the oil or for any other purpose. If you hear a change in the sound of the exhaust or if you drive over something that strikes the underneath side of the car, have the exhaust system checked as soon as possible.

o Do not run the engine in an enclosed area.

Letting the engine idle in your garage, even with the garage door open, is a hazardous practice. Never run the engine in your garage any longer than it takes to start the engine and back the car out.

o Avoid idling the engine for prolonged periods with people inside the car.

If it is necessary to idle the engine for a prolonged period with people inside the car, be sure to do so only in an open area with the air intake set at "Fresh" and fan operating at one of the higher speeds so fresh air is drawn into the interior.

If you must drive with the trunk open because you are carrying objects that make this necessary:

1. Close all windows.
2. Open side vents.
3. Set the air intake control at "Fresh", the air flow control at "Floor" or "Face" and the fan at one of the higher speeds.

To assure proper operation of the ventilation system, be sure the ventilation air intakes located just in front of the windshield are kept clear of snow, ice, leaves or other obstructions.

DRIVING YOUR HYUNDAI

ZC03A1-A

BEFORE STARTING THE ENGINE

Before you start the engine, you should always:

1. Look around the vehicle to be sure there are no flat tires, puddles of oil or water or other indications of possible trouble.
2. After entering the car, check to be sure the parking brake is engaged.
3. Check your seat, seatback and headrest to be sure they are in their proper positions.
4. Check the position of the interior and exterior mirrors.
5. Lock all the doors.
6. Fasten your seat belt and be sure that all other occupants have fastened theirs.
7. Turn off all lights and accessories that are not needed.
8. When you turn the ignition switch to "ON" check that all appropriate warning lights are operating and that you have sufficient fuel.

DC04A1-A

COMBINATION IGNITION SWITCH AND STEERING LOCK

To Start the Engine

Before starting the engine:

- o If your Hyundai is equipped with a manual transaxle, place the shift lever in neutral and depress the clutch.

NOTE:

For safety, the engine will not start if the clutch pedal is not depressed fully.

- o If your Hyundai has an automatic transaxle, place the shift lever in "P" (park).

NOTE:

The ignition key cannot be removed unless the shift lever is in the "P" (park) position. (If installed).

To start the engine, insert the ignition key and turn it to the "START" position. Release it as soon as the engine starts. Do not hold the key in the "START" position for more than 15 seconds.

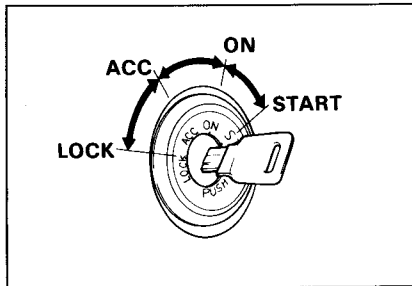

ZC05A1-A

KEY POSITIONS

CAUTION:

The engine should not be turned off or the key removed from the ignition key cylinder while the car is in motion.

"ON"

When the key is in the "ON" position, the ignition is on and all accessories may be turned on. If the engine is not running, the key should not be left in the "ON" position. This will discharge the battery and may also damage the ignition system.

NOTE:

For additional information about starting, see page 2-4.

"ACC"

With the key in the "ACC" position, the radio and other accessories may be operated. If you open the driver's door with the key in the "ACC" or "LOCK" position, the chime will sound to remind you that the key should be removed.

"LOCK"

The key can be removed or inserted in this position. Steering is locked by removing the key. When unlocking the steering, insert the key, and then turn the steering wheel and key simultaneously.

DRIVING YOUR HYUNDAI

ZC06A1-A

STARTING

Normal starting with either a cold or warm engine is obtained without pumping or depressing the accelerator pedal. Simply turn the key to the "Start" position and release when the engine starts.

After the engine has started, allow the engine to run for 10 to 20 seconds prior to placing the vehicle in gear.

The starter should not be operated for more than 15 seconds at a time. Wait 15-30 seconds between starting attempts to protect the starter from overheating.

WARNING

Never run the engine in a closed or poorly ventilated area any longer than is needed to move your car in or out of the area. The carbon monoxide gas emitted is odorless and can be fatal.

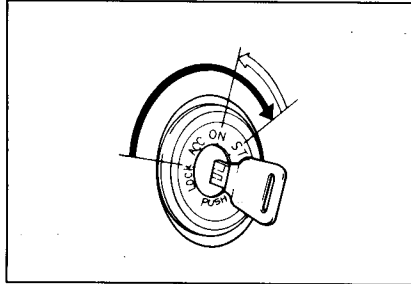

2-4

DC07A1-A

NORMAL CONDITIONS

The Starting Procedure:

1. Insert key, and fasten the seat belt.
2. Place the gearshift lever (manual transaxle) in neutral or the selector lever (automatic transaxle) in "P" (park) position.
3. After turning the ignition key to the "ON" position, make certain all warning lights and gauges are functioning properly before starting the engine.

WARNING

Be sure that the clutch is fully depressed when starting a manual transaxle vehicle. Otherwise, there is the potential to cause damage to the vehicle or injury to someone inside or outside the vehicle as a result of the forward or backward movement of the vehicle that will occur if the clutch is not depressed when the vehicle is started.

4. Turn the ignition key to the "Start" position and release when the engine starts.

DC08A1-A

OPERATING THE MANUAL TRANSAXLE

Your Hyundai's manual transaxle has a conventional shift pattern. This shift pattern is also imprinted on the shift knob. The transaxle is fully synchronized in all forward gears so shifting to either a higher or a lower gear is easily accomplished.

NOTE:

To shift into reverse, place the lever in neutral for at least 3 seconds after your car is completely stopped. Then move the lever into the reverse position.

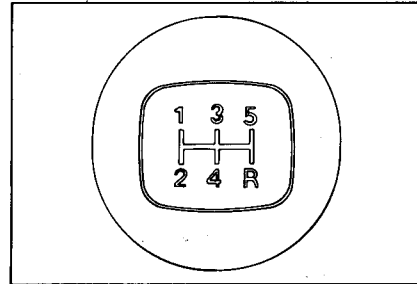

DRIVING YOUR HYUNDAI

ZC09B1-A

Using the Clutch

The clutch should be pressed all the way to the floor before shifting, then released slowly. Do not rest your foot on the clutch pedal while driving. This can cause unnecessary wear. Do not partially engage the clutch to hold the car on an incline. This causes unnecessary wear. Use the parking brake to hold the car on an incline. Do not operate the clutch pedal rapidly and repeatedly.

ZC09D1-A

To remove the ignition key (Manual Transaxle)

1. Turn the ignition key to the "ACC" position.
2. Simultaneously push and turn the ignition key counterclockwise from the "ACC" position to the "LOCK" position.
3. The key can be removed in the "LOCK" position.

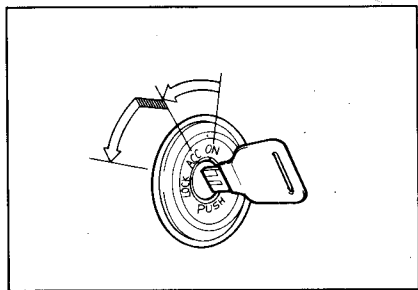

ZC09C1-A

Good Driving Practices

- o Never take the car out of gear and coast down a hill. This is extremely hazardous. Always leave the car in gear.
- o Don't "ride" the brakes. This can cause them to overheat and malfunction. Instead, when you are driving down a long hill, slow down and shift to a lower gear. When you do this, engine braking will help slow the car.
- o Slow down before shifting to a lower gear. This will help avoid over-revving the engine, which can cause damage.
- o Slow down when you encounter cross winds. This gives you much better control of your car.
- o Be sure the car is completely stopped before you attempt to shift into reverse. The transaxle can be damaged if you do not. To shift into reverse, depress the clutch, move the shift lever to neutral, wait a moment, then shift to the reverse position.
- o Exercise extreme caution when driving on a slippery surface. Be especially careful when braking, accelerating or shifting gears. On a slippery surface, an abrupt change in engine speed can cause the drive wheels to lose traction and the vehicle to go out of control.

ZC10A1-A

RECOMMENDED SHIFT SPEEDS

The shift speeds as shown below are recommended for optimum fuel economy and performance.

Shift from-to	Recommended mph (km/h)
1-2 or 2-1	15 (20)
2-3 or 3-2	25 (40)
3-4 or 4-3	35 (55)
4-5 or 5-4	45 (75)

DRIVING YOUR HYUNDAI

ZC11A1-A

AUTOMATIC TRANSAXLE

The highly efficient Hyundai automatic transaxle has four forward speeds and one reverse speed. It has a conventional shift pattern as shown below.

At night, with the side markers or head lights switched on, the appropriate symbol on the quadrant will be illuminated according to the range selected.

CAUTION:

Never shift into "R" or "P" position while the car is moving.

→ **Push the button when shifting**

⇒ **The selector lever can be shifted freely.**

For optimum fuel economy, accelerate gradually. The transaxle will automatically shift to the second, third and overdrive gears.

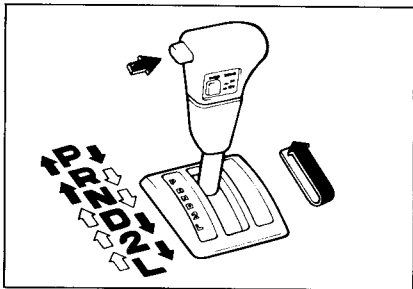

ZC11B1-A

The function of each position is as follows:

o P (Park):

Use to hold the vehicle in place when parking or while starting the engine; shift the select lever to the "P" position. Whenever parking the car, apply the parking brake and shift the selector lever to the "P" position.

CAUTION:

Never place the selector lever in the "P" position unless the vehicle is fully stopped. Failure to observe this caution will cause severe damage to the transaxle.

ZC11C1-A

o R(Reverse):

Use for backing up the vehicle. Bring the car to a complete stop before shifting the selector lever to "R" position.

ZC11D1-A

o N (Neutral):

In the "N" position, the transaxle is in neutral, which means that no gears are engaged. The engine can be started with the shift lever in "N" position, although this is not recommended except when the engine dies and the car is moving.

ZC11E1-A

o D (Drive):

Use for normal driving. The transaxle will automatically shift through a four-gear sequence, giving best economy and power.

Never downshift manually to "2" position or "L" position when vehicle speed is more than 60 mph (95 km/h).

ZC11F1-A

o 2 (Second gear):

Use for driving on a slippery road, hill climbing or engine braking downhill. "2" automatically shifts between 1st and 2nd gears.

This means that no shift-up to 3rd gear is performed. However, the shift-up to 3rd gear is done when the car speed exceeds a certain value to prevent the engine from over-revving.

Manually move the selector to "D" returning to normal driving condition.

DC11G1-A

o L (Low gear):

Use for driving up a very steep grade or for engine braking when descending steep hills. When downshifting to "L", the transaxle will temporarily remain in second gear until the vehicle has slowed enough for low gear to engage. Do not exceed 31 mph (50 km/h) in low gear.

"L" shifts 1st gear only. However, upshift to 2nd is performed when the car exceeds a certain speed, and as the speed increases, upshift to 3rd gear is performed to prevent over-revving the engine.

DRIVING YOUR HYUNDAI

ZC11H1-A

NOTE:

- o For smooth operation, depress the brake pedal when shifting from **NEUTRAL** or **PARK** to a forward or reverse gear.
- o The ignition key must be in the "ON" position and the brake pedal fully depressed in order to move the shift lever from the "P" (Park) position to any of the other positions.
- o It is always possible to shift from "R", "N", "D", "2", "L" position to "P" position.

ZC11H1-A

CAUTION:

- o Shift into "R" and "P" only when the vehicle has completely stopped.
- o Do not accelerate the engine in the reverse or any of the forward positions with the brakes applied.
- o Always apply the footbrake when shifting from "P" or "N", to R, 2 or L.
- o Do not use the P (Park) position in place of the parking brake. Always set the parking brake, shift the transaxle into P (Park) and turn off the ignition when you leave the vehicle, even momentarily.
Never leave the vehicle unattended while the engine is running.
- o Check the automatic transaxle fluid level regularly, and add fluid as necessary.

DC11J1-A

SHIFT LOCK RELEASE

If you cannot move the shift lever from the "P" (Park) position to any other position with the brake pedal fully depressed and the ignition key in the "ON" position, push the shift lock release button. Then, with the brake pedal depressed, move the shift lever to the desired position. The shift lock release button will automatically return to its original position after shifting from the "P" (Park) position.

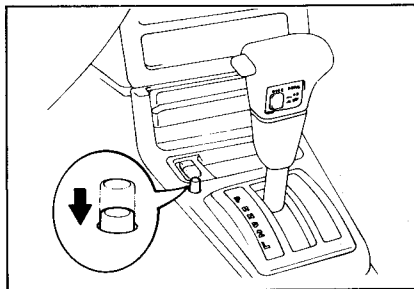

ZC12A1-A

Driving with Electronic Dual-range Automatic Transaxle

The electronically controlled dual-range (Normal/Economy) 4 speed automatic transaxle is available for your Hyundai. The new automatic transaxle features the latest electronics to realize precise and reliable transaxle control by fingertip "Normal/Economy" switchover.

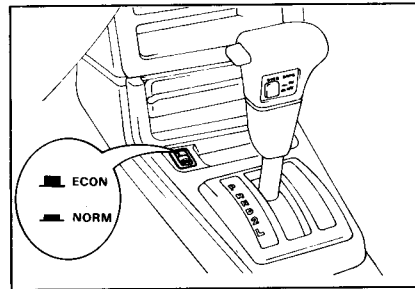

DRIVING YOUR HYUNDAI

ZC12B1-A

To Drive with "Economy" Mode

The "Economy" mode offers quiet and smooth auto-shifting with outstanding fuel economy. The "Economy" mode is recommended for normal driving. Set the driving pattern selector switch to the "ECON" position.

Shift the selector lever to the "D" range and depress the accelerator pedal slowly. If you need rapid acceleration, fully depress the accelerator pedal.

NOTE:

When the transaxle is in "Economy" mode and the vehicle speed is over 60 mph (100 km/h), the transaxle will not downshift into a lower gear when the accelerator pedal is depressed. The "Normal" mode must be selected for the transaxle to downshift.

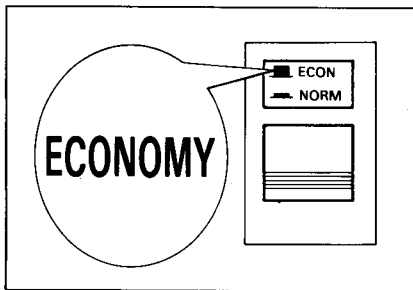

ZC12C1-A

To Drive with "Normal" Mode

In the "Normal" mode you can obtain full potential of the engine for maximum acceleration and driveability. The "Normal" mode is recommended for higher speeds than the "Economy" mode, driving in mountainous area and strong acceleration. Set the driving pattern selector switch to the "NORM" position.

NOTE:

When the engine coolant temperature is low below 20°C (68°F), the transaxle will be in the "Economy" mode even though "Normal" mode is selected.

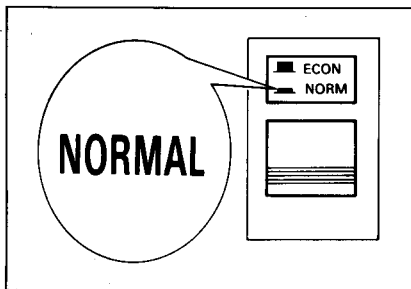

ZC12D1-A

Good Driving Practices

- o Never move the gear selector lever from "P" or "N" to any other position with the accelerator pedal depressed.
- o Never move the gear selector lever into "P" when the vehicle is in motion.
- o Be sure the car is completely stopped before you attempt to shift into "R".
- o Never take the car out of gear and coast down a hill. This is extremely hazardous. Always leave the car in gear when moving.
- o Do not "ride" the brakes. This can cause them to overheat and malfunction. Instead, when you are driving down a long hill, slow down and shift to a lower gear. When you do this, engine braking will help slow the car.
- o Slow down before shifting to a lower gear. Otherwise, the lower gear may not be engaged.
- o Always use the parking brake. Do not depend on placing the transaxle in "P" to keep the car from moving.

DRIVING YOUR HYUNDAI

- o Exercise extreme caution when driving on a slippery surface. Be especially careful when braking, accelerating or shifting gears. On a slippery surface, an abrupt change in engine speed can cause the drive wheels to lose traction and the vehicle to go out of control.
- o Turn the overdrive switch on for good fuel economy and smooth driving. But if engine braking is needed in the "D" range or if repeated upshifting and downshifting between the 3rd and 4th gear is needed when climbing a gentle slope, it is recommended that the overdrive switch be turned off. Turn the overdrive switch back on immediately afterward.

ZC13A1-A

OVERDRIVE SWITCH

When the overdrive switch is turned on, the transaxle will automatically upshift to the second, third and overdrive gears. When the overdrive switch is turned off, the transaxle will not upshift to the overdrive gear at all. For normal driving, the selector lever should be left in the "D" position and turn the overdrive switch on. To move the selector lever, the push button on the selector lever handle may have to be depressed first.

If you need to accelerate rapidly, press the accelerator pedal all the way to the floor. The transaxle will automatically shift to a lower gear, depending on the speed.

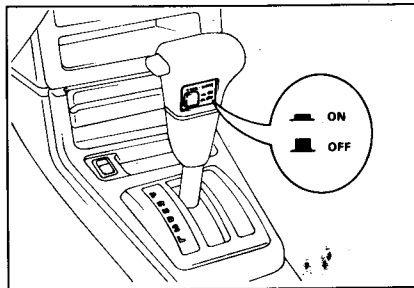

DC14A1-A

GOOD BRAKING PRACTICES

WARNING

Nothing should be carried on top of the cargo area cover behind the rear seat. If there were an accident or a sudden stop, such objects could move forward and cause damage to the vehicle or injure the occupants.

- o After being parked, check to be sure the parking brake is not engaged and that the parking brake indicator light is out before driving away.
- o Driving through water may get the brakes wet. They can also get wet when the car is washed. Wet brakes can be dangerous! Your car will not stop as quickly if the brakes are wet and it may also pull to one side. To dry the brakes, apply the brakes lightly until the braking action returns to normal, taking care to keep the car under control at all times. If the braking action does not return to normal, stop as soon as it is safe to do so and call your Hyundai dealer for assistance.
- o Don't coast down hills with the car out of gear. This can be dangerous. Keep the car in gear at all times, use the brakes to slow down, then shift to a lower gear so that engine braking will help you maintain a safe speed.
- o Don't "ride" the brake pedal. Resting your foot on the brake pedal while driving can be dangerous because it can result in the

DRIVING YOUR HYUNDAI

brakes overheating and losing their effectiveness. It also increases the wear of the brake components.

- o If a tire goes flat while you are driving, apply the brakes gently and keep the car pointed straight ahead while you slow down. When you are moving slowly enough for it to be safe to do so, pull off the road and stop in a safe place.
- o If your car is equipped with an automatic transaxle, don't allow it to creep forward. To avoid creeping forward, keep your foot on the brake pedal when the car is stopped.
- o Use caution when parking on a hill. Engage the parking brake and place the gear selector lever in "P" (automatic transaxle) or in first or reverse gear (manual transaxle). If your car is facing downhill, turn the front wheels into the curb or towards the side of the road. If your car is facing uphill, turn the front wheels away from the curb to help keep the car from rolling. If there is no curb or if it is required by other conditions to keep the car from rolling, block the wheels.
- o Under some conditions your parking brake can freeze in the engaged position. This is most likely to happen when there is an accumulation of snow or ice around or near the rear brakes or if the brakes are wet. If you think the parking brake may freeze, apply it only temporarily while you put the gear selector lever in "P"

(automatic) or in first or reverse gear (manual transaxle) and block the rear wheels so the car cannot roll. Then release the parking brake.

DC15A1-A

DRIVING FOR ECONOMY

You can save fuel and get more miles from your car if you follow these suggestions:

- o Drive smoothly. Accelerate at a moderate rate. Don't make "jack-rabbit" starts or full-throttle shifts and maintain a steady cruising speed. Don't race between stoplights. Try to adjust your speed to that of the other traffic so you don't have to change speeds unnecessarily. Avoid heavy traffic whenever possible. Always maintain a safe distance from other vehicles so you can avoid unnecessary braking. This also reduces brake wear.
- o Drive at a moderate speed. The faster you drive, the more fuel your car uses. Driving at a moderate speed, especially on the highway, is one of the most effective ways to reduce fuel consumption.
- o Don't "ride" the brake or clutch pedal. This can increase fuel consumption and also increase wear on these components. In addition, driving with your foot resting on the brake pedal may cause the brakes to overheat, which reduces their effectiveness and may lead to more serious consequences.

- o Take care of your tires. Keep them inflated to the recommended pressure. Incorrect inflation, either too much or too little, results in unnecessary tire wear. Check the tire pressures at least once a month.
- o Be sure that the wheels are aligned correctly. Improper alignment can result from hitting curbs or driving too fast over irregular surfaces. Poor alignment causes faster tire wear and may also result in other problems as well as greater fuel consumption.
- o Keep your car in good condition. For better fuel economy and reduced maintenance costs, maintain your car in accordance with the maintenance schedule in Section 5. If you drive your car in severe conditions, more frequent maintenance is required (see Section 5 for details).
- o Keep your car clean. For maximum service, your Hyundai should be kept clean and free of corrosive materials. It is especially important that mud, dirt, ice, etc. not be allowed to accumulate on the underside of the car. This extra weight can result in increased fuel consumption and also contribute to corrosion.
- o Travel lightly. Don't carry unnecessary weight in your car. Weight is an enemy of good fuel economy.
- o Don't let the engine idle longer than necessary. If you are waiting (and not in traffic), turn off your engine and restart only when you're ready to go.

DRIVING YOUR HYUNDAI

dai does not require extended warm-up. As soon as the engine is running smoothly, you can drive away. In very cold weather, however, give your engine a slightly longer warm-up period.

- o Don't "lug" or "over-rev" the engine. Lugging is driving too slowly in too high a gear resulting in the engine bucking. If this happens to you, shift to a lower gear. Over-revving is racing the engine beyond its safe limit. This can be avoided by shifting at the recommended speeds.
- o Use your air conditioning sparingly. The air conditioning system is operated by the engine so your fuel economy is reduced when you use it.

ZC16A1-A

SMOOTH CORNERING

Avoid braking or gear changing in corners, especially when roads are wet. Ideally, corners should always be taken under gentle acceleration. If you follow these suggestions, tire wear will be held to a minimum.

ZC17A1-A

WINTER DRIVING

The more severe weather conditions of winter result in greater wear and other problems. To minimize the problems of winter driving, you should follow these suggestions:

ZC17B1-A

Snow or Icy Conditions

To drive your vehicle in deep snow, it may be necessary to use snow tires or to install tire chains on your tires. If snow tires are needed, it is necessary to select tires equivalent in size and type to the original equipment tires. Failure to do so may adversely affect the safety and handling of your car.

Furthermore, speeding, rapid acceleration, sudden brake applications, and sharp turns are potentially very hazardous practices.

During deceleration, use engine braking to the fullest extent. Sudden brake applications on snowy or icy roads may cause skids to occur. You need to keep sufficient distance between the vehicle in operation in front and your vehicle. Also, apply the brake gently. It should be noted that installing tire chains on the tire will provide a greater driving force, but will not prevent side skids.

NOTE:

Tire chains are not legal in all states. Check state laws before fitting tire chains.

ZC17C1-A

Use High Quality Ethylene Glycol Coolant

Your Hyundai is delivered with high quality ethylene glycol coolant in the cooling system. It is the only type of coolant that should be used because it helps prevent corrosion in the cooling system, lubricates the water pump and prevents freezing. Be sure to replace or replenish your coolant in accordance with the maintenance schedule in Section 5. Before winter, have your coolant tested to assure that its freezing point is sufficient for the temperatures anticipated during the winter.

ZC17D1-A

Check Battery and Cables

Winter puts additional burdens on the battery system. Visually inspect the battery and cables as described in Section 6. The level of charge in your battery can be checked by your Hyundai dealer or a service station.

ZC17E1-A

Change to "Winter Weight" Oil if Necessary

In some climates it is recommended that a lower viscosity "winter weight" oil be used during cold weather. See Section 9 for recommendations. If you aren't sure what weight oil you should use, consult your Hyundai dealer.

DRIVING YOUR HYUNDAI

ZC17F1-A

Check Spark Plugs and Ignition System

Inspect your spark plugs as described in Section 6 and replace them if necessary. Also check all ignition wiring and components to be sure they are not cracked, worn or damaged in any way.

ZC17G1-A

To Keep Locks from Freezing

To keep the locks from freezing, squirt an approved de-icer fluid or glycerine into the key opening. If a lock is covered with ice, squirt it with an approved de-icing fluid to remove the ice. If the lock is frozen internally, you may be able to thaw it out by using a heated key. Handle the heated key with care to avoid burning the fingers.

ZC17H1-A

Use Approved Anti-Freeze in Window Washer System

To keep the water in the window washer system from freezing, add an approved anti-freeze solution in accordance with instructions on the container. Window washer anti-freeze is available from Hyundai dealers and most auto parts outlets. Do not use engine coolant or other types of anti-freeze as these may damage the finish.

ZC17H1-A

Don't Let Your Parking Brake Freeze

Under some conditions your parking brake can freeze in the engaged position. This is most likely to happen when there is an accumulation of snow or ice around or near the rear brakes or if the brakes are wet. If you think the parking brake may freeze, apply it only temporarily while you put the gear selector lever in "P" (automatic) or in first or reverse gear (manual transaxle) and block the rear wheels so the car cannot roll. Then release the parking brake.

ZC17J1-A

Don't Let Ice and Snow Accumulate Underneath

Under some conditions, snow and ice can build up under the fenders and interfere with the steering. When driving in severe winter conditions where this may happen, you should periodically check underneath the car to be sure the movement of the front wheels and the steering components are not obstructed.

ZC17K1-A

Carry Emergency Equipment

Depending on the severity of the weather where you drive your car, you should carry appropriate emergency equipment. Some of the items you may want to carry include tire chains, tow straps or chains, flashlight, emergency flares, sand, a shovel, jumper

cables, a window scraper, gloves, ground cloth, coveralls, a blanket, etc.

ZC18A1-A

HIGH SPEED MOTORING

Pre-Trip Inspections

1. Tires;
Adjust the tire inflation pressures for highway driving. Low tire inflation pressures will result in overheating and possible failure of the tires. Avoid using worn or damaged tires which may result in reduced adhesion or tire failure.

NOTE:

Never exceed the maximum tire inflation pressure shown on the tires.

2. Fuel, engine coolant and engine oil;
High speed travel consumes 1.5 times more fuel than urban motoring. Do not forget to check both engine coolant and engine oil.
3. Drive belt;
A loose or damaged drive belt may result in overheating of the engine.

ZC19A1-A

USE OF LIGHTS

Check your lights regularly for correct operation and always keep them clean. When driving during the day in conditions of poor visibility, it is helpful to drive with headlights on low beam. This enables you to be seen as well as to see.

DRIVING YOUR HYUNDAI

YC20A1-A

TRAILER OR VEHICLE TOWING

If you are considering towing with your car, you should first check with your State's Department of Motor Vehicles to determine their legal requirements.

Since laws vary from state to state, the requirements for towing trailers, cars, or other types of vehicles or apparatus may differ. Ask your Hyundai dealer for further details before towing.

WARNING

Do not do any towing with your car during its first 1,200 miles (2,000km) in order to allow the engine to properly breaking in. Failure to heed this warning may result in serious engine or transaxle damage.

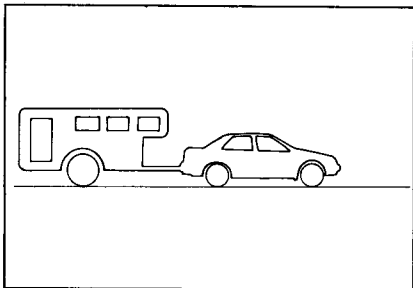

YC20B1-A

Trailer Hitches

Select the proper hitch and ball combination, making sure that it's location is compatible with that of the trailer or vehicle being towed.

Use a quality non-equalizing hitch which distributes the tongue load uniformly throughout the chassis.

Maintain 10% of the trailer load on the trailer tongue for dead weight hitches.

Tongue loads can be increased or decreased by re-distributing the load in the trailer.

This can be verified by checking the total weight of the loaded trailer and then checking the load on the tongue.

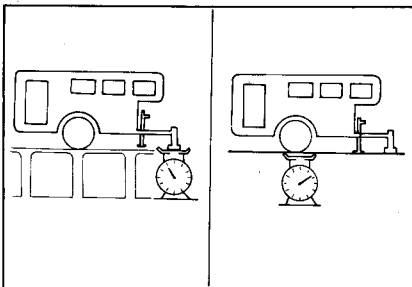

YC20C1-A

Trailer Brakes

If your trailer is equipped with a braking system, make sure it conforms to federal and/or local regulations and that it is properly installed.

NOTE:

If you tow a trailer or vehicle, your car will require more frequent maintenance due to the additional load. See "Maintenance Under Severe Usage Conditions" on page 5-5.

YC20D2-A

Safety Chains

Should the hitch connection between your car and the trailer or vehicle you are towing fail, the trailer or vehicle could wander dangerously across other lanes of traffic and ultimately leave the roadway to collide with another vehicle. To eliminate this potentially dangerous situation, safety chains, attached between your car and the trailer or towed vehicle, are required in most states.

DRIVING YOUR HYUNDAI

CAUTION:

This following specifications are recommended when towing a trailer. The loaded trailer weight cannot safely exceed the values in the chart below.

Lbs. (kg)

	Maximum Towable Weight	
	Trailer	Tongue
With Trailer Brake	2205 (1000)	220.5 (100)
Without Trailer Brake	1543 (700)	154.3 (70)

NOTE:

Total gross vehicle weight with trailer must not exceed the Gross Vehicle Weight Rating (GVWR) of vehicle. The total gross vehicle weight is the weight of the vehicle, driver, passengers, luggage or cargo, plus the weight of the hitch and trailer tongue weight.

YC20E1-A

Trailer or Vehicle Towing Tips

1. Avoid jerky starts, sudden acceleration or sudden stops.
2. Avoid sharp turns and rapid lane changes.
3. Before towing, check hitch and safety chain connections for proper operation of the trailer running lights, brake lights, and turn signals.

NOTE:

When towing check transaxle fluid more frequently.

CAUTION:

If overheating should occur when towing, (temperature gauge reads near red zone), taking the following action may reduce or eliminate the problem.

1. Turn off the air conditioner.
2. Reduce highway speed.
3. Select a lower gear when going uphill.
4. While in stop and go traffic, place the gear selection in park or neutral and idle the engine at a higher speed.

ZD01A1-A

3. TROUBLE ON THE ROAD

What to do in an Emergency

WHAT TO DO IN AN EMERGENCY

ZD02A1-A

IF THE ENGINE WILL NOT START

CAUTION:

If the engine will not start, do not push or pull the car to start it. This could result in a collision or cause other damage. In addition, push or pull starting may cause the catalytic converter to be overloaded and create a fire hazard.

ZD02B1-A

If Engine Doesn't Turn Over or Turns Over Slowly

1. If your car has an automatic transaxle be sure the gear selector lever is in "N" or "P" and the emergency brake is set.
2. Check the battery connections to be sure they are clean and tight.
3. Turn on the interior light. If the light dims or goes out when you operate the starter, the battery is discharged.

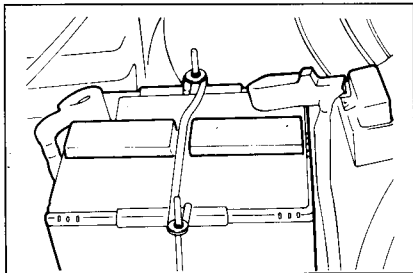

4. Do not push or pull the vehicle to start it. See instructions for "Jump Starting" on the following pages.

ZD02C1-A

If Engine Turns Over Normally but Does Not Start

1. Check fuel level.
2. Check all connectors at distributor, coil and spark plugs. Replace any that may be disconnected or loose.
3. If engine still refuses to start, call a Hyundai dealer or seek other qualified assistance.

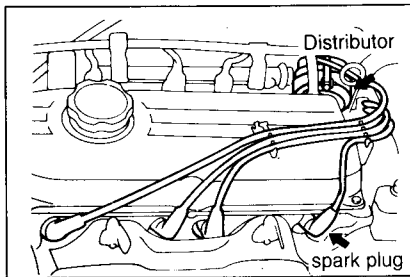

DD03A1-A

JUMP STARTING

WARNING

Jump starting can be dangerous! If these instructions are not followed exactly, serious personal injury and damage to the vehicle may occur! If you are not sure how to follow this procedure, seek qualified assistance. Automobile batteries contain sulfuric acid. This is poisonous and highly corrosive. When jump starting, wear protective glasses and be careful not to get acid on yourself, your clothing or on the car.

- o If you should accidentally get acid on your skin or in your eyes, immediately remove any contaminated clothing and flush the area with clear water for at least 15 minutes. Then promptly obtain medical attention. If you must be transported to an emergency facility, continue to apply water to the affected area with a sponge or cloth.

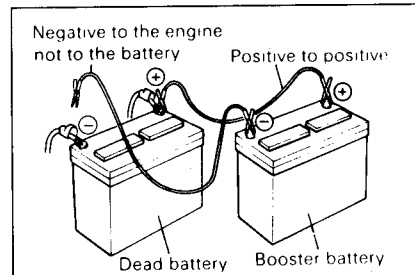

WHAT TO DO IN AN EMERGENCY

- o The gas produced by the battery during the jump-start operation is highly explosive. Do not smoke or allow a spark or open flame in the vicinity.
- o The battery being used to provide the jump start must be 12-volt. If you cannot determine that it is a 12-volt battery, do not attempt to use it for jump starting.
- o To jump start a car with a discharged battery, follow this procedure exactly:
 1. If the booster battery is installed in another vehicle, be sure the two vehicles are not touching.
 2. Turn off all unnecessary lights and accessories in both vehicles.
 3. If applicable, remove all vent caps from both batteries. Check the fluid level in the discharged battery and replenish if required, preferably with distilled water. Next, cover the open vents with rags or pieces of cloth. This is done to reduce the spread of dangerous gases and the chance of explosion.
 4. Attach the clamps of the jumper cable in the exact order shown on the previous page. That is, first, attach one clamp of the jumper cable to the positive (+) post or cable of the discharged battery. Then attach the other end of the same cable to the positive (+) post or cable of the booster battery. Next, using the other cable, attach

- one clamp to the negative (-) post or cable of the booster battery. Then attach the other end of that cable to a solid metal part of the engine away from the battery. Do not connect the cable to any moving part.
5. Start the engine in the car with the booster battery and let it run for a few minutes. This will help to assure that the booster battery is fully charged. During the jumping operation, run the engine in this vehicle at about 2000 rpm.
 6. Start your engine using the normal starting procedure. After the engine starts, leave the jumper cables connected and let the engine run at fast idle or about 2000 rpm for several minutes.
 7. Following the exact reverse order of their being attached, carefully remove the jumper cables. Remove the negative cable first, then the positive cable.
 8. Carefully remove the pieces of cloth that were used to cover the batteries and dispose of them. These cloths may now be contaminated with sulfuric acid.
 9. Replace battery vent caps.

If you do not know why your battery became discharged (because the lights were left on, etc.), have the charging system checked by your Hyundai dealer.

DD04A1-A

IF THE ENGINE OVERHEATS

If your temperature gauge indicates overheating, you experience a loss of power, or hear loud pinging or knocking, the engine is probably too hot. If this happens to you, you should:

1. Pull off the road and stop as soon as it is safe to do so.
2. Place the gear selector lever in "P" (automatic), or neutral (manual transaxle) and set the parking brake. If the air conditioner is on, turn it off.
3. If coolant is running out under the car or steam is coming out from the hood, stop the engine. Do not open the hood until the coolant has stopped running or the steaming has stopped. If there is no visible loss of coolant and no steam, leave the engine running and check to be sure the engine cooling fan is operating. If the fan is not running, turn the engine off.
4. Check to see if the water pump drive belt is missing. If it is not missing, check to see that it is tight. If the drive belt seems to be satisfactory, check for coolant leaking from the radiator, hoses or under the car. (If the air conditioner had been in use, it is normal for cold water to be draining from it when you stop).

WHAT TO DO IN AN EMERGENCY

WARNING

While the engine is running, keep hands and clothing away from moving parts such as the fan and drive belts to prevent injury.

5. If the water pump drive belt is broken or coolant is leaking out, stop the engine immediately and call the nearest Hyundai dealer for assistance.

WARNING

Do not remove the radiator cap when the engine is hot. This can allow coolant to be blown out of the opening and cause serious burns.

6. If you cannot find the cause of the overheating, wait until the engine temperature has returned to normal. Then, if coolant has been lost, carefully remove the radiator cap and add water to bring the fluid level in the reservoir up to the base of the radiator fill opening. Then fill the coolant recovery tank to the halfway mark.
7. Proceed with caution, keeping alert for further signs of overheating. If overheating happens again, call a Hyundai dealer for assistance.

CAUTION:

Serious loss of coolant indicates there is a leak in the cooling system and this should be checked as soon as possible by a Hyundai dealer.

DD05A1-A

SPARE TIRE

The following instructions for the spare tire should be observed:

- o Check inflation pressure as soon as practical after installing the spare tire, and adjust to the specified pressure. The tire pressure should be periodically checked and maintained at the specified pressure while the tire is stored.

Spare Tire Pressure

Type	Inflation Pressure
Temporary Spare Tire	414 kPa (60 psi)

Temporary Spare Tire

1. The spare tire should only be used temporarily and should be returned to the luggage compartment as soon as the original tire can be repaired or replaced.
2. Continuous use at speeds of over 80 km/h (50 mph) is not recommended.
3. As the temporary spare tire is specifically designed for your car, it should not be used on any other vehicle.
4. The temporary spare tire should not be used on any other wheels, nor should standard tires, snow tires, wheel covers or trim rings be used with the temporary spare wheel. If such use is attempted,

damage to these items or other car components may occur.

5. The temporary spare tire pressure should be checked once a month while the tire is stored.

CAUTION:

- o **Do not use snow chains with your temporary spare tire.**
- o **Do not use more than one temporary spare tire at a time.**

DD05C1-A

Handling the Spare Tire

Remove the installation bolt to remove the spare tire.

To replace the spare tire in its storage compartment, tighten the bolt firmly with your fingers until the spare tire is secure.

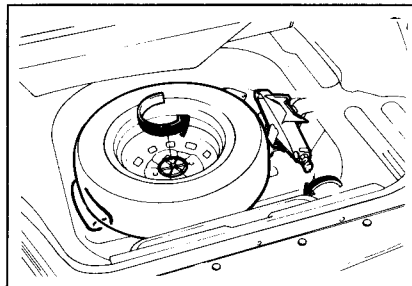

WHAT TO DO IN AN EMERGENCY

ZD06A1-A

IF YOU HAVE A FLAT TIRE

If a tire goes flat while you are driving:

1. Take your foot off the accelerator pedal and let the car slow down while driving straight ahead. Do not apply the brakes immediately or attempt to pull off the road as this may cause a loss of control. When the car has slowed to a speed when it is safe to do so, brake carefully and pull off the road. Drive off the road as far as possible and park on firm, level ground. If you are on a divided highway, do not park in the median area between the two traffic lanes.
2. When the car is stopped, turn on your emergency hazard flashers, set the parking brake and put the transaxle in "P" (automatic) or reverse (manual transaxle).
3. Have all passengers get out of the car. Be sure they all get out on the side of the car that is away from traffic.
4. Change the tire following the instructions provided on the following pages.

ZD07A1-A

CHANGING A FLAT TIRE

The procedure described on the following pages can be used to rotate tires as well as to change a flat tire. When preparing to change a flat tire, check to be sure the gear selector lever is in "P" (automatic) or reverse gear (manual transaxle) and that the parking brake is set, then:

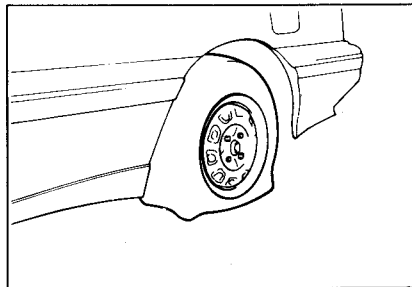

ZD07B1-A

1. Obtain Spare Tire and Tool

Remove the spare tire and take out the jack and tool bag from the trunk.

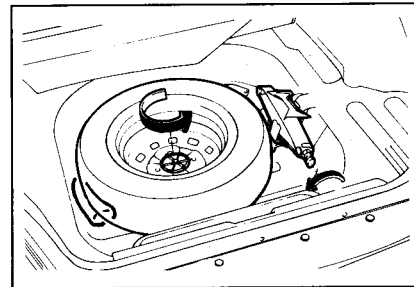

WHAT TO DO IN AN EMERGENCY

ZD07D1-A

2. Block the Wheel

Block the wheel that is diagonally opposite from the flat to keep the vehicle from rolling when the car is raised on the jack.

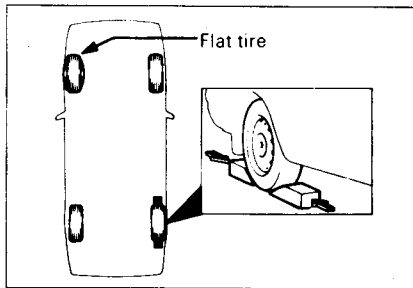

ZD07E2-A

3. Remove Wheel Cover (If installed)

1. Insert the flattened end of the wrench between the wheel cover and rim about 5-10 mm.
2. Pull the wrench head toward you about 15 degrees.
3. Hit the wrench head about 2 or 3 times with your hand.
4. Make use of the fully opened gap to remove the wheel cover with your hand.

WARNING

Wheel covers may have sharp edges. Remove wheel covers only by the method described above. Removal by any other method may result in injury or severe lacerations.

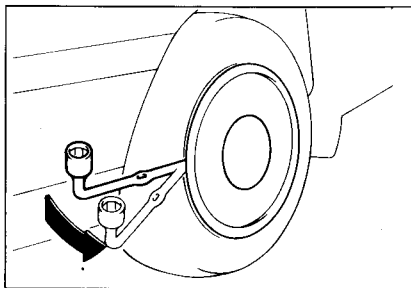

DD07F1-A

4. Loosen Wheel Nuts

The wheel nuts should be loosened slightly before raising the car. To loosen the nuts, turn the wrench handle counterclockwise. When doing this, be sure that the socket is seated completely over the nut so it cannot slip off. For maximum leverage position the wrench so the handle is to the right as shown in the drawing. Then, while holding the wrench near the end of the handle, pull up on it with steady pressure. Do not remove the nuts at this time. Temporarily loosen them about one-half turn.

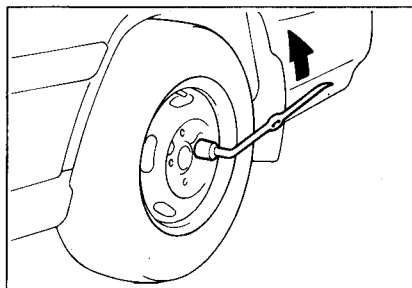

WHAT TO DO IN AN EMERGENCY

ZD07G1-A

5. Put the Jack in Place

The base of the jack should be placed on firm, level ground. The jack should be positioned as shown in the drawing.

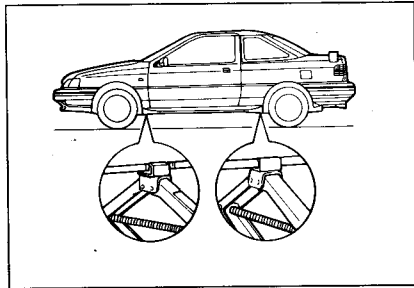

ZD07H2-A

6. Raising the Car

Install the bar and wrench into the jack as shown in the drawing. To raise the vehicle, turn the jack handle clockwise. As the jack begins to raise the vehicle, double check that it is properly positioned and will not slip. If the jack is on soft ground or sand, you may find it necessary to place a board, brick, flat stone or other object under the base of the jack to keep it from sinking.

Raise the car high enough so that the fully inflated spare tire can be installed. To do this, you will need more ground clearance than is required to remove the flat tire.

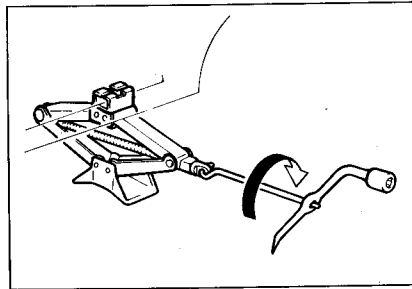

WARNING

Do not get under the car when it is supported by the jack! This is very dangerous as the vehicle could fall and seriously injure you. No one should stay in the car while the jack is being used.

DD07I2-A

7. Changing Wheels

Use the wrench to loosen the wheel nuts, then remove them with your fingers. Slide the wheel off the studs and lay it flat so it cannot roll away. To put the wheel on the hub, pick up the spare tire, line up the holes with the studs and slide the wheel into position. If this is difficult, tip the wheel slightly and get the top hole in the wheel lined up with the top stud. Then jiggle the wheel back and forth until the wheel can be slid over the other studs.

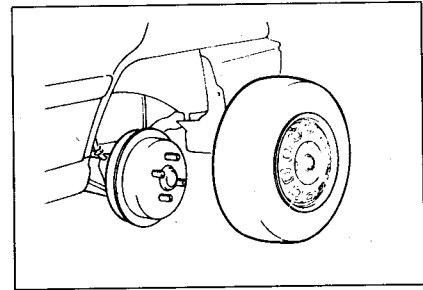

WHAT TO DO IN AN EMERGENCY

CAUTION:

Before putting the wheel into place, be sure that there is nothing on the hub or wheel (such as mud, tar, gravel, etc.) that interferes with the wheel fitting solidly against the hub. If there is, remove it. If there is not good contact on the mounting surface between the wheel and hub, the wheel nuts could come loose and cause the loss of a wheel.

ZD07J1-A

8. Re-install Wheel Nuts

Put the wheel nuts on the studs and tighten them finger tight. The nuts should be installed with their small diameter ends directed inward. Jiggle the tire to be sure it is completely seated, then tighten the nuts with your fingers again.

ZD07K2-A

9. Lower Vehicle and Tighten Nuts

Lower the car to the ground by turning the wrench counterclockwise. Then position the wrench as shown in the drawing and tighten the wheel nuts. Be sure the socket is seated completely over the nut. Do not stand on the wrench handle or use an extension pipe over the wrench handle.

Go around the wheel tightening every other nut until they are all tight. Then double-check each nut for tightness. After changing wheels, have a technician tighten the wheel nuts to their proper torque as soon as possible.

Wheel nut tightening torque

Steel wheel & aluminium alloy wheel:
65-80 lb.ft (900-1,100 kg.cm)

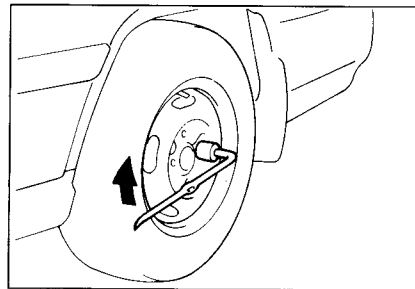
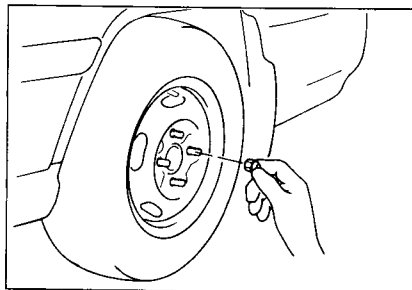
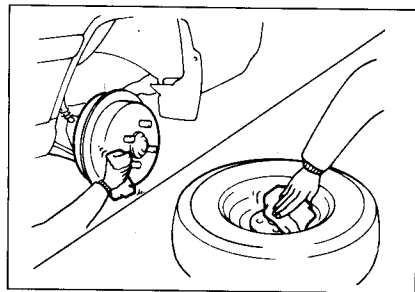

WHAT TO DO IN AN EMERGENCY

DD07L1-A

10. Re-install Wheel Cover (If installed)

To re-install the wheel cover, hold it in position and firmly tap it with the side or heel of your hand until it snaps into place.

WARNING

Wheel covers may have sharp edges. Handle them carefully to avoid possible injury or severe lacerations.

If you have a tire gauge, remove the valve cap and check the air pressure. If the pressure is lower than recommended, drive slowly to the nearest service station and inflate to the correct pressure. If it is too high, adjust until it is correct. Always re-install the valve cap after checking or adjusting tire pressure. If the cap is not replaced, the valve core could be damaged by dirt or moisture and cause air to leak from the tire.

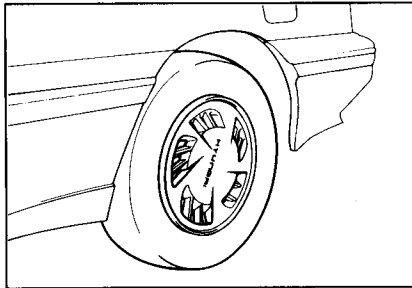

If you lose a valve cap, buy another and install it as soon as possible.

ZD07M1-A

AFTER CHANGING WHEELS

After you have changed wheels, always secure the flat tire in its place in the trunk and return the jack and tools to their proper storage locations.

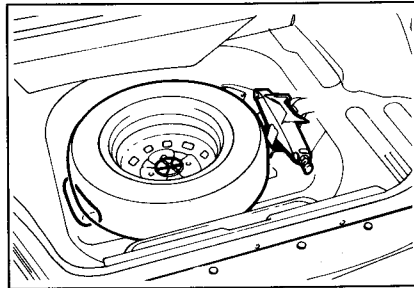

ZD08A1-A

IF YOUR CAR MUST BE TOWED

CAUTION:

Your car can be damaged if towed incorrectly!

If your car has to be towed, it should be done by your Hyundai dealer or a commercial tow truck service. This will help assure that your car is not damaged in towing. Also, professionals are generally aware of state and local laws governing towing. In any case, rather than risk damage to your car, it is suggested that you show this information to the tow truck operator. Be sure that a safety chain system is used and that all state and local laws are observed.

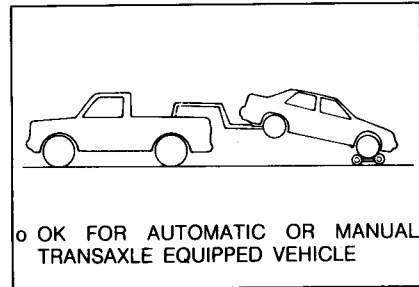

WHAT TO DO IN AN EMERGENCY

ZD09A1-A

TOWING A CAR WITH MANUAL TRANSAXLE

- o If the car is being towed with the rear wheels on the ground, be sure the parking brake is released.
- o If the car is being towed with the front wheels on the ground, be sure that the transaxle is in neutral. Also, be sure that the ignition key is in the "ACC" position. This is necessary to prevent damage to the steering lock mechanism, which is not designed to hold the front wheels straight while the car is being towed.
- o If any of the loaded wheels or suspension components are damaged, a towing dolly must be used.

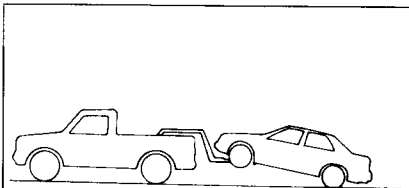

- o OK FOR AUTOMATIC OR MANUAL TRANSAXLE EQUIPPED VEHICLE WITH NO DAMAGE

ZD10A1-A

TOWING A CAR WITH AUTOMATIC TRANSAXLE

CAUTION:

A car with an automatic transaxle should never be towed from the rear with the front wheels on the ground. This can cause serious damage to the transaxle. If the car must be towed from the rear, a towing dolly must be used under the front wheels.

- o If the car is being towed with the rear wheels on the ground, be sure the parking brake is released.
- o If the car is being towed with all four wheels on the ground, it can be towed only from the front. Be sure that the transaxle is in neutral. Do not tow at speeds greater than 30 mph (45 kph) and for more than 50 miles (80 km).

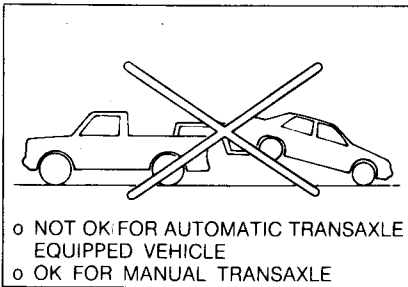

- o NOT OK FOR AUTOMATIC TRANSAXLE EQUIPPED VEHICLE
- o OK FOR MANUAL TRANSAXLE

Be sure steering is unlocked by placing the key in the "ACC" position. A driver must be in the towed vehicle to operate steering and brakes.

NOTE:

Before towing, check the level of the transaxle fluid. If it is below the "HOT" mark on the dipstick, add fluid. If you cannot add fluid, a towing dolly must be used as described above.

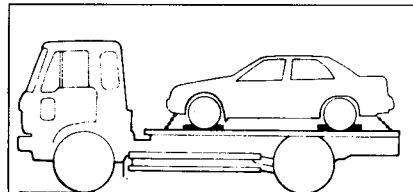

- o OK FOR AUTOMATIC OR MANUAL TRANSAXLE EQUIPPED VEHICLE

WHAT TO DO IN AN EMERGENCY

ZD11A1-A

EMERGENCY TOWING

For emergency towing when no commercial tow vehicle is available, attach a tow cable, chain or strap to one of the tie-down hooks under the front of your car. Do not attempt to tow your vehicle in this manner on any unpaved surface. This could result in serious damage to your car.

Nor should it be attempted if the wheels, drive train, axles, steering or brakes are damaged. Before towing, be sure the transaxle is in neutral and the key in "ACC" (with the engine off) or in the "ON" position (with the engine running). A driver must be in the towed car to steer it and operate the brakes.

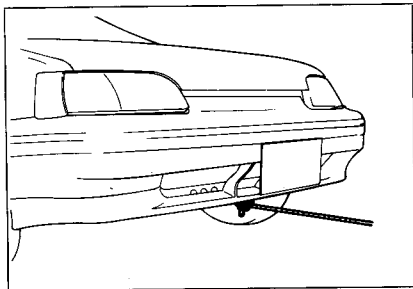

ZD12A1-A

IF YOU LOSE YOUR KEYS

If you lose your keys, many Hyundai dealers can make you a new key if you have your key number.

If you lock the keys inside your car and you cannot obtain a new key, many Hyundai dealers can use special tools to open the door for you.

ZE01A1-A

4. KEEPING THOSE GOOD LOOKS

Corrosion Prevention & Appearance Care

CORROSION PREVENTION AND APPEARANCE CARE

ZE02A1-A

PROTECTING YOUR HYUNDAI FROM CORROSION

By using the most advanced design and construction practices to combat corrosion, Hyundai produces cars of the highest quality. However, this is only part of the job. To achieve the long-term corrosion resistance your Hyundai can deliver, the owner's cooperation and assistance is also required.

ZE02B1-A

Common Causes of Corrosion

The most common causes of corrosion on your car are:

- o Road salt, dirt and moisture that is allowed to accumulate underneath the car.
- o Removal of paint or protective coatings by stones, gravel, abrasion or minor scrapes and dents which leave unprotected metal exposed to corrosion.

ZE02C1-A

High-Corrosion Areas

If you live in an area where your car is regularly exposed to corrosive materials, corrosion protection is particularly important. Some of the common causes of accelerated corrosion are road salts, dust control chemicals, ocean air and industrial pollution.

ZE02D1-A

Moisture Breeds Corrosion

Moisture creates the conditions in which corrosion is most likely to occur. For example, corrosion is accelerated by high humidity, particularly when temperatures are just above freezing. In such conditions, the corrosive material is kept in contact with the car surfaces by moisture that is slow to evaporate. Mud is a particular enemy of corrosion protection because it is slow to dry and holds moisture in contact with the vehicle. Even though the mud appears to be dry, it can still retain the moisture and promote corrosion.

High temperatures can also accelerate corrosion of parts that are not properly ventilated so the moisture can be dispersed. For all these reasons, it is particularly important to keep your car clean and free of mud or accumulations of other materials. This applies not only on the visible surfaces but particularly to the underside of the car.

ZE03A1-A

TO HELP PREVENT CORROSION

You can help prevent corrosion from getting started by observing the following:

ZE03B1-A

Keep Your Car Clean

The best way to prevent corrosion is to keep your car clean and free of corrosive materials. Attention to the underside of the car is particularly important.

- o If you live in a high-corrosion area -- where road salts are used, near the ocean, areas with industrial pollution, acid rain, etc.-- You should take extra care to prevent corrosion. In winter, hose off the underside of your car at least once a month and be sure to clean the underside thoroughly when winter is over.
- o When cleaning underneath the car, give particular attention to the components under the fenders and other areas that are hidden from view. Do a thorough job; just dampening the accumulated mud, rather than washing it away, will accelerate corrosion rather than prevent it. Water under high pressure and steam are particularly effective in removing accumulated mud and corrosive materials.
- o When cleaning lower door panels, rocker panels and frame members, be sure that drain holes are kept open so that moisture can escape and not be trapped inside to accelerate corrosion.

CORROSION PREVENTION AND APPEARANCE CARE

ZE03C1-A

Keep Your Garage Dry

Don't park your car in a damp, poorly ventilated garage. This creates a favorable environment for corrosion. This is particularly true if you wash your car in the garage or drive it into the garage when it is still wet or covered with snow, ice or mud. Even a heated garage can contribute to corrosion unless it is well ventilated so moisture is dispersed.

ZE03D1-A

Keep Paint and Trim in Good Condition

Scratches or chips in the finish should be covered with "touch-up" paint as soon as possible to reduce the possibility of corrosion. If bare metal is showing through, the attention of a qualified body and paint shop is recommended.

ZE03E1-A

Don't Neglect the Interior

Moisture can collect under the floor mats and carpeting to cause corrosion. Check under the mats periodically to be sure the carpeting is dry. Use particular care if you carry fertilizers, cleaning materials or chemicals in the car.

These should be carried only in proper containers and any spills or leaks should be cleaned up, flushed with clear water and thoroughly dried.

ZE04A1-A

WASHING AND WAXING

Washing Your Hyundai

Never wash your car when the surface is hot from being in the sun. Always wash your car in the shade.

Wash your car frequently. Dirt is abrasive and can scratch the paint if it is not removed. Air pollution or acid rain may damage the paint and trim through chemical action if pollutants are allowed to remain in contact with the surface. If you live near the ocean or in an area where road salts or dust control chemicals are used, you should pay particular attention to the underside of the car. Start by rinsing the car to remove dust and loose dirt. In winter, or if you have driven through mud or muddy water, be sure to thoroughly clean the underside as well. Use a hard direct stream of water to remove accumulations of mud or corrosive materials. Use a good quality car-washing solution and follow the manufacturer's directions on the package. These are available at your Hyundai dealer or auto parts outlet. Don't use strong household detergents, gasoline, strong solvents or abrasive cleaning powders as these may damage the finish.

Use a clean sponge or cloth, rinse it frequently and don't damage the finish by rubbing too hard. For stubborn spots, dampen them frequently and remove them a little at a time.

To clean whitewall tires, use a stiff brush or soap-impregnated steel-wool scouring pad.

To clean plastic wheel covers, use a clean sponge or soft cloth and water.

To clean cast aluminum alloy wheels, use a mild soap or neutral detergent. Do not use abrasive cleaners. Protect the bare-metal surfaces by cleaning, polishing and waxing. Because aluminum is subject to corrosion, be sure to give aluminum alloy wheels special attention in winter. If you drive on salted roads, clean the wheels thoroughly afterwards.

After washing, be sure to rinse thoroughly. If soapy water dries on the finish, streaking will result.

When the weather is warm and the humidity low, you may find it necessary to rinse each section immediately after washing to avoid streaking.

After rinsing, dry the car using a damp chamois or soft, absorbent cloth. The reason for drying the car is to remove water from the car so it will dry without water spots. Don't rub, this can damage the finish.

If you find any nicks or scratches in the paint, use touch-up paint to cover them to prevent corrosion.

CORROSION PREVENTION AND APPEARANCE CARE

ZE04B1-A

Spot Cleaning

Don't use gasoline, strong solvents or corrosive cleaning agents. These can damage the finish of the car. To remove road tar, use turpentine on a clean, soft cloth. Be gentle.

To remove dead insects or tree sap, use warm water and mild soap or car-washing solution. Soak the spot and rub gently. If the paint has lost its luster, use a commercial car-cleaning polish.

ZE04C1-A

Polishing and Waxing

Always wash and dry the car before polishing or waxing or using a combination cleaner and wax. Use a good quality commercial product and follow the manufacturer's directions on the container. Polish and wax the bright trim pieces as well as the paint.

ZE04D1-A

When to Wax Again

You should polish and wax the car again when water no longer beads on a clean surface but spreads out over a larger area.

ZE04E1-A

Maintaining Bumpers

Special precautions must be observed to preserve the appearance of the bumpers on your Hyundai. They are:

- o Be careful not to spill battery electrolyte or hydraulic brake fluid on the bumpers. If you do, wash it off immediately with clear water.
- o Be gentle when cleaning the bumper surfaces. They are made of soft plastic and the surface can be damaged if mistreated. Do not use abrasive cleaners. Use warm water and mild soap or car-washing solution.
- o Do not expose the bumpers to high temperatures. For example, if you have your car repainted, do not leave the bumpers on the car if the car is going to be placed in a high-temperature paint booth.

ZE05A1-A

CLEANING THE INTERIOR

To Clean the Vinyl Upholstery

To clean the vinyl upholstery, first remove loose dirt and dust with a vacuum cleaner. Then apply a solution of mild soap or detergent and water using a clean sponge or soft cloth. Allow this to stay on the surface to loosen the dirt, then wipe with a clean damp sponge or cloth. If all the dirt stains are not removed, repeat this procedure until the upholstery is clean. Do not use gasoline, solvent, paint thinner or other strong cleaners.

ZE05B1-A

Cleaning the Carpets

Use a foam-type carpet cleaner. Cleaners of this type are available in aerosol cans in

liquid form or powder. Read the instructions and follow them exactly. Using a vacuum cleaner with the appropriate attachment, remove as much dirt from the carpets as possible. Apply the foam following the manufacturer's directions, then rub in overlapping circles. Do not add water. These cleaners work best when the carpet is kept as dry as possible.

ZE05C1-A

Cleaning the Seat Belts

To clean the seat belts, use a cloth or sponge with mild soap or detergent and warm water. Do not use strong detergents, dye, bleach or abrasive materials on the seat belts as this may weaken the fabric.

While cleaning the belts, inspect them for excessive wear, cuts, fraying or other signs of damage and replace them if necessary.

ZE05D1-A

Cleaning the Windows

You may use any household window cleaner on the windows. However, when cleaning the inside of the rear window be careful not to damage the rear window defroster wiring.

ZE05E1-A

Any Questions?

If you have any questions about the care of your car, consult your Hyundai dealer.

ZF01A1-A

5. THE KEY TO TROUBLE-FREE OPERATION

Vehicle Maintenance Requirements

VEHICLE MAINTENANCE REQUIREMENTS

DF02A1-A

MAINTENANCE AND SERVICE REQUIREMENTS

To assure that you receive the greatest number of miles of satisfying operation from your Hyundai Scoupe, certain maintenance procedures must be performed. Although careful design and engineering have reduced these to a minimum, those that are required are of the utmost importance.

It is your responsibility to have these maintenance procedures performed to comply with the terms of the warranties covering your new Hyundai. The Owner's Handbook supplied with your new vehicle provides further information about these warranties.

ZF02B1-A

Maintenance Requirements

The maintenance required for your Hyundai can be divided into three main areas:

- o Specified scheduled procedures
- o General everyday checks
- o Do-it-yourself maintenance

ZF02C1-A

Specified Scheduled Procedures

These are the procedures such as inspections, adjustments and replacements that are listed in the maintenance charts starting on page 5-3. These procedures must be performed at

the intervals shown in the maintenance schedule to assure that your warranty remains in effect. Although it is strongly recommended that they be performed by the factory-trained technicians at your Hyundai dealer, these procedures may be performed at any qualified service facility.

It is suggested that genuine Hyundai service parts be used for any required repairs or replacements. Other parts of equivalent quality may be used without affecting your warranty coverage but you should always be sure these are equivalent to the quality of the original Hyundai parts. Your Owner's Handbook provides further information about your warranty coverage.

ZF02D1-A

General Everyday Checks

These are the everyday checks you should perform each time you drive your Hyundai or when you fill the fuel tank. A list of these items will be found on page 6-3.

ZF02E1-A

Do-It-Yourself Maintenance

If you are mechanically inclined, own a few tools that are required and want to take the time to do so, you can inspect and service a number of items. For more information about doing it yourself, see the Section 6.

ZF02F1-A

A Few Tips

- o Whenever you have your Hyundai serviced, keep copies of the service records in your glovebox. This will help assure that you can document that the required procedures have been performed to keep your warranties in effect. This is especially important when service is not performed at an authorized Hyundai dealer.
- o If you choose to do your own maintenance and repairs, you may find it helpful to have an official Hyundai Shop Manual. A copy of this publication may be purchased at your Hyundai dealer's parts department.

ZF03A1-A

SCHEDULED MAINTENANCE REQUIREMENTS

Inspection should be performed any time a malfunction is experienced or suspected.

Receipts for all emission control system services should be retained to demonstrate compliance with conditions of the emissions system warranty.

For severe usage maintenance requirements, see page 5-5 of this section.

VEHICLE MAINTENANCE REQUIREMENTS

ZF04A1-A

SCHEDULED MAINTENANCE

The following maintenance services must be performed to assure good emission control and performance. Keep receipts for all vehicle emission services to protect your emission warranty.

Where both mileage and time are shown, the frequency of service is determined by whichever occurs first.

DF04B1-A

R : REPLACE I : INSPECT AND, AFTER INSPECTION, CLEAN, ADJUST, REPAIR OR REPLACE IF NECESSARY

NO.	DESCRIPTION	MILES X 1000	7.5	15	22.5	30	37.5	45	52.5	60
		KILOMETERS X 1000	12	24	36	48	60	72	84	96
		MONTHS	5	10	20	30	40	50	60	70
EMISSION CONTROL ITEMS										
1	ENGINE OIL AND FILTER		R	R	R	R	R	R	R	R
2	VALVE CLEARANCE			I		I		I		I
3	FUEL FILTER								R	
4	FUEL LINES AND CONNECTIONS								I	
5	VACUUM, CRANKCASE VENTILATION HOSES								I	
6	FUEL HOSE, VAPOR HOSE & FUEL FILLER CAP								I	
7	AIR CLEANER FILTER					R				R
8	SPARK PLUGS					R				R

VEHICLE MAINTENANCE REQUIREMENTS

DF04C1-A

R : REPLACE I : INSPECT AND, AFTER INSPECTION, CLEAN, ADJUST, REPAIR OR REPLACE IF NECESSARY

NO.	DESCRIPTION	MILES X 1000	7.5	15	22.5	30	37.5	45	52.5	60
		KILOMETERS X 1000	12	24	36	48	60	72	84	96
		MONTHS	5	10	20	30	40	50	60	70
GENERAL ITEMS										
1	DRIVE BELT (WATER PUMP AND ALTERNATOR)					I				I
2	ENGINE COOLANT					R				R
3	TIMING BELT									R
4	MANUAL TRANSAXLE OIL					I				I
5	AUTO TRANSAXLE OIL		I			R		I		R
6	BRAKE FLUID					R				R
7	BRAKE HOSES, LINES					I		I		I
8	REAR BRAKE DRUMS/LININGS/PARKING BRAKE					I				I
9	BRAKE PADS, CALIPERS, ROTORS			I		I		I		I
10	EXHAUST PIPE CONNECTIONS, MUFFLER & SUSPENSION BOLTS					I				I
11	STEERING GEAR RACK, LINKAGE & BOOTS					I				I
12	WHEEL BEARING GREASE					I				I
13	DRIVESHAFTS & BOOTS			I		I		I		I

VEHICLE MAINTENANCE REQUIREMENTS

DF05D1-A

MAINTENANCE UNDER SEVERE USAGE CONDITIONS

The following items must be serviced more frequently on vehicles normally used under severe driving conditions. Refer to the chart below for the appropriate maintenance intervals.

(I = Inspect, correct or replace if necessary, R : Replace.)

Maintenance Item	Maintenance Operation	Maintenance Intervals	Driving Condition
Engine Oil and Filter	R	Every 3,000 miles (4,800 km) or 3 Months	A, B, C, F, H
Air Cleaner Filter	R	More frequently	C, E
Spark Plugs	R	Every 24,000 miles (40,000 km) or 18 Months	B, H
Brake Pads, Calipers, Rotors	I	More frequently	C, D, G, H
Rear Brake Drums/Linings	I	More frequently	C, D, G, H
Steering Gear Rack Linkage & Boots	I	Every 7,500 miles (12,000 km) or 6 Months	C, D, E, F, G
Driveshafts & Boots	I	Every 7,500 miles (12,000 km) or 6 Months	C, E, F

Severe Driving Conditions

- A — Repeated short distance driving
- B — Extensive idling
- C — Driving in dusty conditions

- D — Driving in areas using salt or other corrosive materials or in very cold weather
- E — Driving in sandy areas
- F — More than 50% driving in heavy city traffic during hot weather above 90°F (32°C)
- G — Driving in mountainous areas
- H — Towing a trailer

VEHICLE MAINTENANCE REQUIREMENTS

ZF06A1-A

EXPLANATION OF SCHEDULED MAINTENANCE ITEMS

DF06B1-A

o Engine oil and filter

The engine oil and filter should be changed at those intervals specified in the maintenance schedule. If the vehicle is being driven under severe conditions, more frequent oil and filter changes are required.

ZF06C1-A

o Drive belts

Inspect all drive belts (for water pump and alternator) for evidence of cuts, cracks, excessive wear or oiliness, and replace if necessary. Drive belts should be checked periodically for proper tension and adjusted as necessary.

ZF06D1-A

o Valve clearances

An incorrect valve clearance will not only result in unsteady engine operation, but will also cause excessive noise and reduced engine output. Inspect valve clearance and adjust as required while the engine is hot.

Valve-to-rocker arm clearance

Intake valves 0.15mm (0.006 in)

Exhaust valves 0.25mm (0.010 in)

ZF06G1-A

o Fuel lines and connections

Check the fuel lines and connections for leakage and damage.

Replace any damaged or leaking parts immediately.

o Fuel filter

A clogged filter can limit the speed at which the vehicle may be driven, damage the emission system and cause hard starting. If an excessive amount of foreign matter accumulates in the fuel tank, the filter may require replacement more frequently.

After installing a new filter, run the engine for several minutes, and check for leaks at the connections.

ZF06H1-A

o Vacuum, and crankcase ventilation hoses

Inspect the surface of hoses for evidence of heat and mechanical damage. Hard and brittle rubber, cracking, tears, cuts, abrasions, and excessive swelling indicate deterioration.

Particular attention should be paid to examining those hose surfaces nearest to high heat sources, such as the exhaust manifold. Inspect the hose routing to assure that the hoses do not come in contact with any heat source, sharp edges or moving component

which might cause heat damage or mechanical wear. Inspect all hose connections, such as clamps and couplings, to make sure they are secure, and that no leaks are present. Hoses should be replaced immediately if there is any evidence of deterioration or damage.

ZF06H1-A

o Fuel hose, vapor hose and fuel filler cap

The fuel hose, vapor hose and fuel filler cap should be inspected at those intervals specified in the maintenance schedule. Make sure that a new fuel hose, vapor hose or fuel filler cap is correctly replaced.

ZF06J1-A

o Air cleaner filter

A genuine Hyundai part is recommended for replacement of the air cleaner filter.

ZF06M1-A

o Spark plugs

Make sure to install new spark plugs of the correct heat range.

ZF07F1-A

o Engine coolant

The coolant should be changed at those intervals specified in the Maintenance Schedule.

VEHICLE MAINTENANCE REQUIREMENTS

DF07G1-A

o Timing belt

Inspect all parts related with the timing belt for damage and deterioration. Replace any damaged parts.

ZF07H1-A

o Manual transaxle oil

Change manual transaxle oil according to the maintenance schedule.

NOTE:

If the oil level is low, check for possible leaks before adding oil. Do not overfill.

ZF07I3-A

o Automatic transaxle fluid

The fluid level should be in the "HOT" range of the dipstick, after engine and transaxle are at normal operating temperature. Check the Automatic Transaxle Fluid level with the engine running and the transaxle in neutral, with the parking brake properly applied.

Use GENUINE HYUNDAI AUTOMATIC TRANSMISSION FLUID, MOPAR ATF PLUS TYPE 7176 or DIAMOND ATF SP, when adding or changing fluid.

ZF07J1-A

o Brake hoses and lines

Visually check for proper installation, chafing, cracks, deterioration and any leakage. Replace any deteriorated or damaged parts immediately.

ZF07K1-A

o Brake fluid

Check brake fluid level in the brake fluid reservoir. The level should be between "MIN" and "MAX" marks on the side of the reservoir. Use only hydraulic brake fluid conforming to DOT 3.

ZF07L1-A

o Rear brake drums and linings

Check for scoring, burning, leaking fluid, broken parts, and excessive wear.

ZF07M1-A

o Brake pads, calipers and rotors

Check the pads for excessive wear, discs for run out and wear, and calipers for fluid leakage.

ZF07N1-A

o Parking brake

Inspect the parking brake system such as parking brake lever, cables, and so on. For detailed service procedures, refer to the Shop Manual.

ZF07O1-A

o Exhaust pipe connections, muffler and suspension bolts

Check the exhaust pipe, muffler, and suspension connections for looseness or damage.

ZF07P1-A

o Steering gear rack, linkage and boots

With the car stopped and engine off, check for excessive freeplay in the steering wheel. Check the linkage for bends or damage. Check the dust boots and ball joints for deterioration, cracks, or damage. Replace any damaged parts.

ZF07Q1-A

o Wheel bearing grease

Check the wheel bearings and grease according to the maintenance schedule. For inspection procedures, see Shop Manual.

ZF07R1-A

o Driveshaft and boots

Check the drive shaft boots and clamps for cracks, deterioration, or damage. Replace any damaged parts and, if necessary, repack the grease.

ZG01A1-A

6. SATURDAY MECHANICS

Do-It-Yourself Maintenance

DO-IT-YOURSELF MAINTENANCE

ZG02A1-A

ENGINE COMPARTMENT

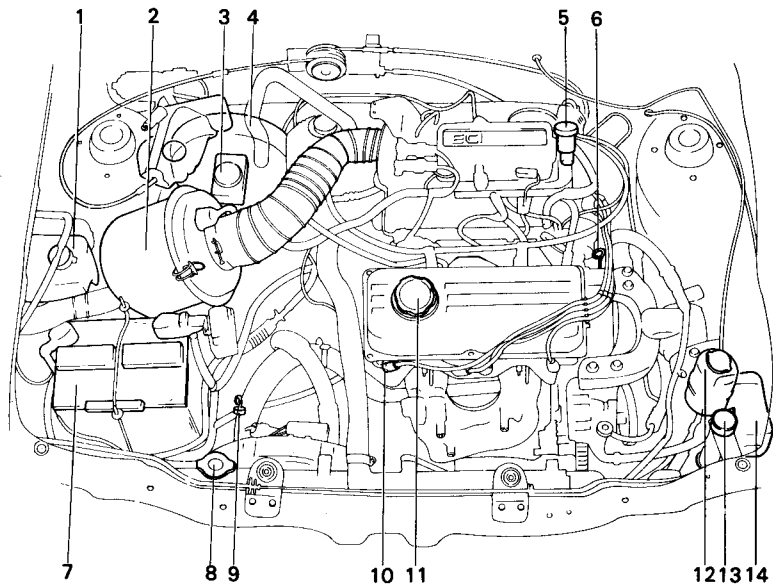

1. Coolant reservoir cap
2. Air cleaner
3. Brake fluid reservoir
4. Brake booster
5. Clutch fluid reservoir

6. Engine oil level dipstick
7. Battery
8. Radiator cap
9. Automatic transaxle fluid level dipstick
(Automatic T/A only)

10. Spark plug
11. Engine oil filler cap
12. Power steering fluid reservoir
13. Windshield washer fluid reservoir cap
14. Relay box

DO-IT-YOURSELF MAINTENANCE

ZG02B2-A

GENERAL EVERYDAY CHECKS

Engine Compartment

The following should be checked regularly:

- o Engine oil level and condition
- o Transaxle fluid level and condition
- o Brake reservoir fluid level
- o Clutch reservoir fluid level
- o Engine coolant level
- o Windshield washer fluid level
- o Accessory drive belt condition
- o Coolant hose condition
- o Air filter element condition
- o Exhaust system condition
- o Fluid leaks (on or below components)
- o Power steering fluid level and condition
- o Battery indicator condition

ZG02C2-A

Vehicle Exterior

The following should be checked monthly:

- o Overall appearance and condition
- o Wheel condition and wheel nut tightness
- o Exhaust system condition
- o Light condition and operation
- o Windshield glass condition
- o Wiper blade condition
- o Paint condition and corrosion
- o Fluid leaks
- o Door and hood lock condition
- o Tire pressure and condition (including spare)

ZG02D1-A

Vehicle Interior

The following should be checked each time when the vehicle is driven:

- o Light operation
- o Windshield wiper operation
- o Horn operation
- o Defroster, heater operation (and air conditioning, if equipped)
- o Steering operation and condition
- o Mirror condition and operation
- o Turn signal operation
- o Accelerator pedal operation
- o Brake operation, including parking brake
- o Manual transaxle operation, including clutch operation
- o Automatic transaxle operation, including "Park" mechanism operation
- o Seat control condition and operation
- o Seat belt condition and operation
- o Sun visor operation

If you notice anything that does not operate correctly or appear to be unfunctioning correctly, inspect it carefully and seek assistance from your Hyundai dealer if service is needed.

DO-IT-YOURSELF MAINTENANCE

ZG03A1-A

CHECKING THE ENGINE OIL

Engine oil is essential to the performance and service of the engine. It is suggested that you check the oil level at least once a week in normal use and more often if you are on a trip or driving in severe conditions.

ZG03B1-A

Recommended Oil

SG or SG/CD (API) multi-grade and fuel efficient oil is recommended.

NOTE:

SAE 5W-20 is not recommended for sustained high speed vehicle operation.

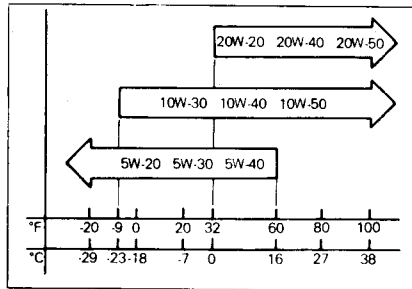

ZG03C1-A

To Check the Oil Level

Before checking the oil, warm up the engine to normal operating temperature and be sure it is parked on level ground. Turn the engine off.

Wait a minute, then remove the dipstick, wipe it off, fully reinsert the dipstick and withdraw it again. Then note the highest level the oil has reached on the dipstick. It should be between the upper ("MAX") and lower ("MIN") range.

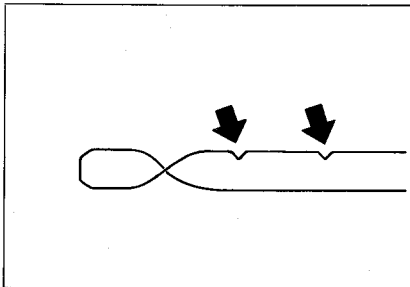

ZG03D1-A

Adding Oil

If the oil level is close to or below the "MIN" mark, add oil until it reaches the "MAX" mark. To add oil:

1. Remove the oil filler cap by turning it counterclockwise.
2. Add oil, then check the level again. Do not overfill.
3. Replace the cap by turning it clockwise.

The distance between the "MAX" and "MIN" marks is equal to about 1 quart of oil.

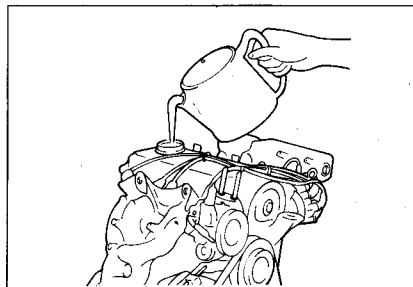

DO-IT-YOURSELF MAINTENANCE

ZG04A1-A

CHANGING THE OIL AND FILTER

The engine oil and filter should be changed at those intervals specified in the maintenance schedule in Section 5. If the car is being driven in severe conditions, more frequent oil and filter changes are required.

The procedure for changing the oil and filter is as follows:

1. Park the car on level ground and set the parking brake. Start the engine and let it warm up until the needle on the temperature gauge moves above the lowest mark. Turn the engine off and place the gear selector lever in "P" (automatic) or reverse gear (manual transaxle).
2. Open the hood and remove the engine oil filler cap.
3. Slide underneath the car and loosen the drain plug by turning it counterclockwise with a wrench of the proper size. Be sure

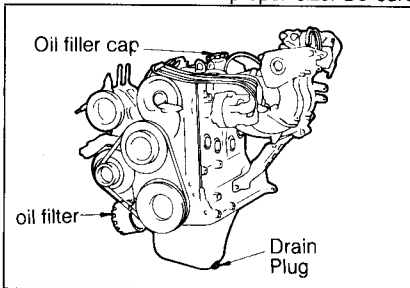

that a drain pan is in position to catch the oil as it drains out, then remove the drain plug.

WARNING

Be very careful when draining the engine oil as it may be hot enough to burn you!

4. When the oil has stopped draining, replace the drain plug using a new washer and retighten by turning it clockwise.
5. Remove the oil filter. You should be able to unscrew the filter with your hands. (If your hands are slippery, try using a cloth between your hands and the filter to give yourself a better grip.) A certain amount of oil will come out when you remove the filter so be sure to have your drain pan in place underneath it.
6. Install a new oil filter in accordance with the instructions on the carton or on the filter itself. Do not over-tighten. Be sure that the mounting surface on the engine is clean and that the old gasket is removed completely. Lubricate the new gasket on the filter before installation with clean engine oil.
7. Refill the crankcase with the recommended engine oil. Refer to the specification in chapter 9 for engine oil capacity.
8. Start the engine and check to be sure no oil is leaking from the drain plug or oil filter.
9. Shut off the engine and recheck the oil level.

NOTE:

Always dispose of used engine oil in an environmentally acceptable manner. It is suggested that it be placed in a sealed container and taken to a service station for reclamation. Do not pour the oil on the ground or put it in with household trash.

WARNING

Used motor oil may cause irritation or cancer of the skin if left in contact with the skin for prolonged periods of time. Although this will probably not be a concern unless you handle used oil on a regular basis, you should wash your hands with soap and warm water as soon as possible after handling used oil.

DO-IT-YOURSELF MAINTENANCE

ZG05A1-A

CHECKING AND CHANGING THE ENGINE COOLANT

WARNING

Do not remove the radiator cap when the engine is hot. When the engine is hot, the coolant is under pressure and may erupt through the opening if the cap is removed. You could be seriously burned if you do not observe this precaution.

ZG05B1-A

Recommended Coolant

Use a high quality ethylene-glycol coolant in a 50/50 mix with water. The coolant should be compatible with aluminum engine parts. No additional corrosion inhibitors or additives should be used. The cooling system must be maintained with the correct concentration and type of coolant to prevent freezing and corrosion.

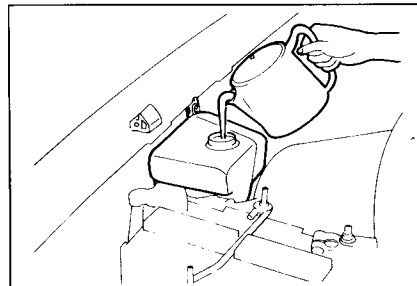

NEVER allow the concentration of antifreeze to exceed the 60% level or go below the 35% level or damage to the coolant system may result. For proper concentration when adding or replacing the coolant, refer to the following table.

Ambient temperature °C (°F)	Coolant concentration	
	Anti-freeze solution	Water
-15 (5)	35%	65%
-25 (-13)	40%	60%
-31 (-35)	50%	50%
-45 (-49)	60%	40%

ZG05C1-A

To Check the Coolant Level

The coolant level can be seen on the side of the plastic coolant reservoir. The level of the coolant should be between the "LOW" and

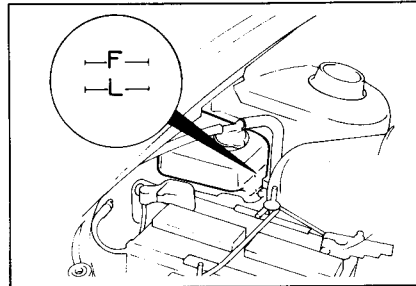

"FULL" lines on the reservoir. If the level is below the "LOW" mark, add coolant to bring it up between "LOW" and "FULL". If the level is low, inspect for coolant leaks and recheck the fluid level frequently. If the level drops again, visit your Hyundai dealer for an inspection and diagnosis of the reason.

ZG05D1-A

To Change the Coolant

The coolant should be changed at those intervals specified in the vehicle maintenance schedule in Section 5.

NOTE:

Coolant can damage the finish of your car. If you spill coolant on the car, wash it off thoroughly with clear water.

1. Park the car on level ground, set the parking brake and remove the radiator cap when cool.
2. Be sure your drain receptacle is in place. Open the drain cock on the radiator. Allow all the coolant to drain from the cooling system, then securely close the drain cock.
3. Check Section 9 for the capacity of the cooling system in your car. Then, following the manufacturer's directions on the coolant container, add the appropriate quantity of coolant to the radiator. Now fill the radiator with clean water. Continue to add water in small quantities until the fluid level stays up in the radiator neck.

DO-IT-YOURSELF MAINTENANCE

4. Start the engine, top off the radiator with water and then add coolant to the reservoir until the level is between "LOW" and "FULL".
5. Replace the radiator and reservoir caps and check to be sure the drain cocks are fully closed and not leaking.

WARNINGS

The radiator fan is controlled by engine coolant temperature and may sometimes operate even after the ignition key has been turned off. Use extreme caution when working near the blades of the cooling fan so that you are not injured by a rotating fan blade. As the coolant temperature decreases, the fan will automatically shut off. This is a normal condition.

ZG06A1-A

REPLACING THE SPARK PLUGS

The spark plugs should be changed at the intervals specified in the vehicle maintenance schedule in Section 5, or whenever engine performance indicates they should be changed. Symptoms that suggest poor spark plug performance include engine misfiring under load, loss of fuel economy, poor acceleration, etc. When spark plugs are replaced, always use spark plugs recommended by Hyundai. The use of other spark plugs can result in loss of performance, radio interference or engine damage.

Recommended Spark Plugs:

CHAMPION : RN9YC4
NGK : BUR6EA-11
BPR6ES-11

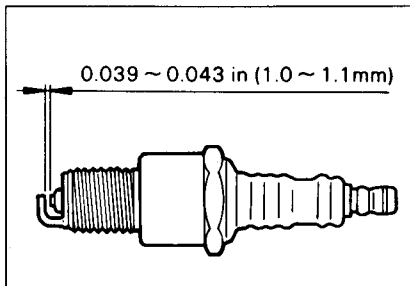

ZG06B1-A

Changing the Spark Plugs

You will find it easier to change spark plugs if the engine is cold.

Always change one spark plug at a time. This helps avoid getting the wires mixed up.

1. Using a clean cloth, remove any dirt that has accumulated around the base of the spark plug so it cannot fall into the cylinder when the spark plug is removed.
2. To remove the spark plug cable, pull straight up on the insulated connector, not the cable. Pulling on the cable may damage the carbon core conductor.

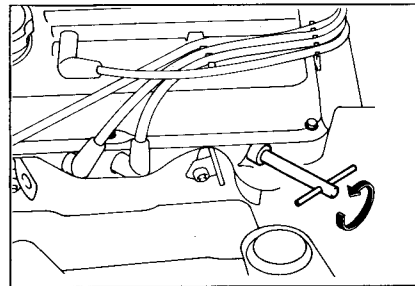

DO-IT-YOURSELF MAINTENANCE

WARNING

It is recommended that the engine be cool or cold when changing the spark plugs. If the engine is hot, you could burn yourself on the insulated connector, the spark plug or the engine itself.

- When preparing to remove the old spark plug, guide the socket down over the spark plug, being careful not to damage the ceramic insulator.
- To remove the spark plug, turn the wrench handle in a counterclockwise direction.
- To replace the new spark plug, guide the socket down over the spark plug, being careful not to damage the ceramic insulator.

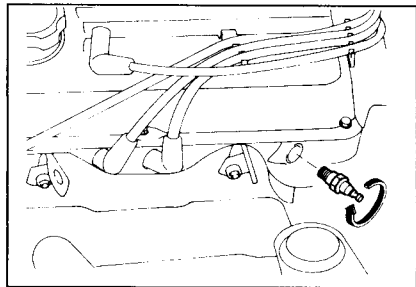

NOTE:

Spark plugs should be tightened firmly. Over-tightening can damage the threads in the aluminum cylinder head. Also, leaving them too loose can cause the spark plug to get very hot and possibly result in damage to the engine.

- Replace the cable by pushing the insulated connector directly down onto the electrode. Check to be sure it has snapped into place and can't fall off.

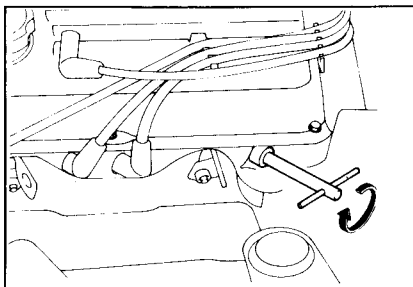

ZG07A1-A

CHANGING THE AIR FILTER

To change the filter, unsnap the clips (1) around the cover. When this is done, the cover can be lifted off, the old filter removed and the new filter put in its place. Genuine Hyundai replacement parts are recommended.

CAUTION:

Operating your vehicle without a proper air filter in place can result in excessive engine wear.

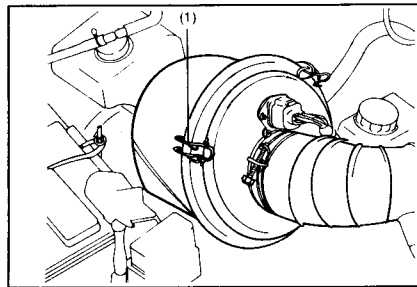

DO-IT-YOURSELF MAINTENANCE

ZG08A1-A

WINDSHIELD WIPER BLADES

The wiper blades should be carefully inspected from time to time and cleaned to remove accumulations of road film or other debris. To clean the wiper blades and arms, use a clean sponge or cloth with a mild soap or detergent and water.

If the wipers continue to streak or smear the glass, replace them with genuine Hyundai replacement parts or their equivalent.

NOTE:

Do not operate the wipers on dry glass. This can result in more rapid wear of the wiper blades and may scratch the glass.

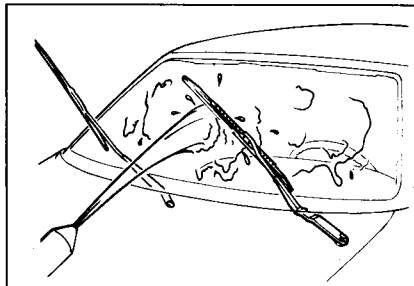

ZG09A1-A

FILLING THE WASHER RESERVOIR

The washer fluid reservoir supplies fluid to the windshield washer system.

A good quality washer fluid should be used to fill the washer reservoir. The fluid level should be checked more frequently during bad weather or whenever the washer system is in more frequent use.

The capacity of the washer reservoir is 3.1 U.S. quarts (3.0 Liters).

- o Radiator anti-freeze (engine coolant) should not be used in the washer system because it will damage the car's finish.
- o The washer button should not be pressed if the washer reservoir is empty. This can damage the washer fluid pump.

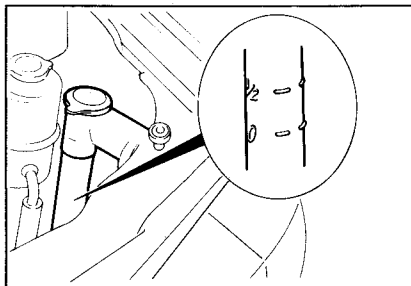

ZG10A1-A

CHECKING THE TRANSAXLE OIL (MANUAL)

Transaxle lubricant in the manual transaxle should be changed at those intervals specified in the vehicle maintenance schedule in Section 5.

Recommended Oil

Use only API GL-4 SAE 75W/85W in the manual transaxle.

Manual Transaxle Oil Capacity

The oil capacity of the manual transaxle is 1.9 U.S. quarts (1.8 liters).

WARNING

It is always better to check the transaxle oil level when the engine is cool or cold. If the engine is hot, you should exercise great caution to avoid burning yourself on hot engine or exhaust parts.

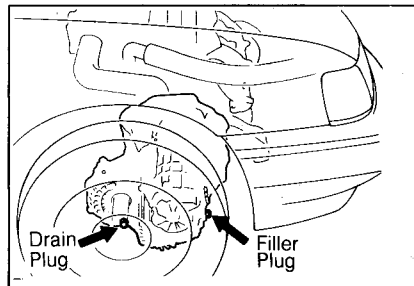

DO-IT-YOURSELF MAINTENANCE

ZG10B1-A

To check the Transaxle Fluid Level

Park the car on level ground with the engine off.

1. Using a wrench of the correct size, loosen the oil filler bolt turning is counterclockwise and remove it with your fingers.
2. Use your finger to feel inside the hole. The oil level should be at its bottom edge. If it is not, check for leaks before adding oil. To refill the transaxle or bring the oil level up, add oil slowly until it reaches the proper level. Do not overfill.
3. Replace the bolt, screw it in with your fingers and then tighten securely with the wrench.

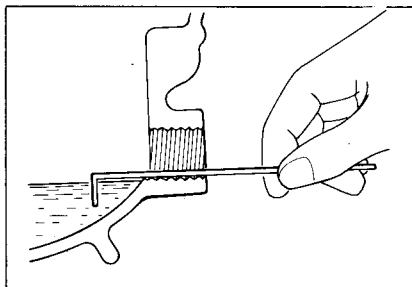

ZG11A1-A

CHECKING THE TRANSAXLE FLUID (AUTOMATIC)

Transaxle fluid in the automatic transaxle should be changed at those intervals specified in the vehicle maintenance schedule in Section 5.

ZG11B3-A

Recommended Fluid

Your Hyundai automatic transaxle is specially designed to operate with GENUINE HYUNDAI AUTOMATIC TRANSMISSION FLUID, MOPAR ATF PLUS TYPE 7176, DIAMOND ATF SP or other equivalent transmission fluid.

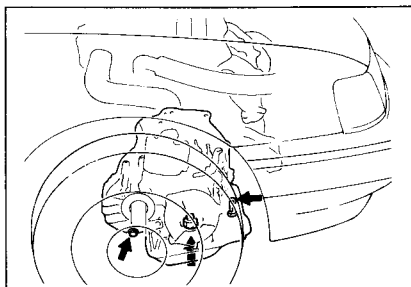

ZG11C1-A

Transaxle Fluid Capacity

The fluid capacity of the automatic transaxle is 6.44 U.S. quarts (6.1 liters).

CAUTION:

The transaxle fluid level should be checked when the engine is at normal operating temperature. This means that the engine, radiator, exhaust system etc., are very hot so you should exercise great care not to burn yourself during this procedure.

ZG11D1-A

To Check the Transaxle Fluid Level

Park the car on level ground with the parking brake engaged. When the transaxle fluid level is checked, the transaxle fluid should be at normal operating temperature and the engine idling.

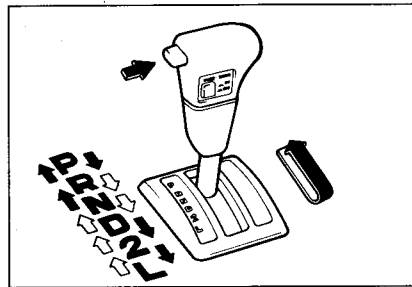

DO-IT-YOURSELF MAINTENANCE

While the engine is idling, apply the brakes and move the gear selector lever from "P" to each of its other positions -- "R", "N", "D", "2", "L" -- and then return to "N". With the engine still idling:

1. Open the hood, being careful to keep hands and clothing clear of any moving parts.
2. Remove the transaxle dipstick, wipe it clean, reinsert the dipstick as far as it will go, then remove it again. Now check the fluid level on the dipstick. It should be in the "HOT" range on the dipstick.

3. If the transaxle fluid level is low, use a funnel to add transaxle fluid through the dipstick tube until the level reaches the "HOT" range.

WARNING

The radiator fan is controlled by engine coolant temperature and may sometimes operate even after the ignition key has been turned off. Use extreme caution when working near the blades of the cooling fan, so that you are not injured by a rotating fan blade. As the coolant temperature decreases, the fan will automatically shut off. This is a normal condition.

ZG12A1-A

CHECKING THE BRAKES

CAUTION:

Because brakes are essential to the safe operation of the car, it is suggested that they be checked and inspected by your Hyundai dealer. The brakes should be checked and inspected for wear at those intervals specified in the vehicle maintenance schedule in Section 5.

ZG12B1-A

Checking the Brake Fluid Level

WARNING

Use caution when handling brake fluid. It can damage your vision if it gets into your eyes. It will also damage your vehicle's paint if spilled on it and not removed immediately.

ZG12C1-A

Recommended Brake Fluid

Use only hydraulic brake fluid conforming to DOT 3 specifications in your braking system. Follow the instructions printed on the container.

ZG12D1-A

To Check the Fluid Level

The fluid level in the brake fluid reservoir should be checked periodically. The level should be between the "MIN" and "MAX" marks on the side of the reservoir. If the level is at or below the "MIN" mark, carefully add fluid to bring it up to "MAX". Do not overfill.

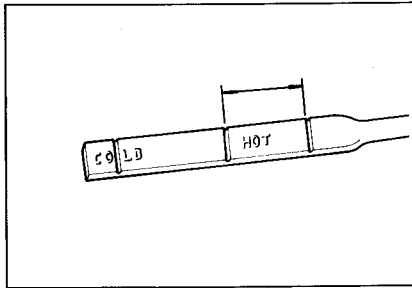
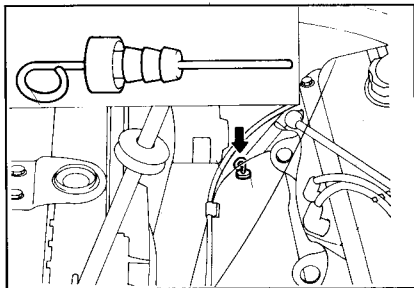

DO-IT-YOURSELF MAINTENANCE

ZG12E1-A

Adding Brake Fluid

WARNINGS

Handle brake fluid carefully. It can damage your vision if it gets into your eyes. Use only DOT 3 specification fluid from a sealed container. Do not allow the fluid can or reservoir to remain open any longer than required. This will avoid entry of dirt and moisture which can damage the brake system and cause improper operation.

To add brake fluid, first wipe away any dirt then unscrew the fluid reservoir cap. Slowly pour the recommended fluid into the reservoir. Do not over fill. Carefully replace the cap on the reservoir and tighten.

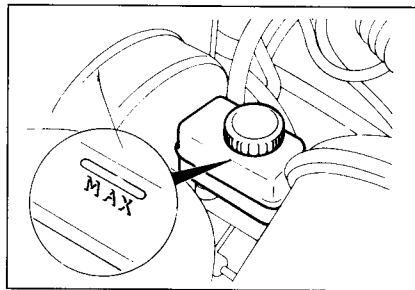

ZG13A1-A

CHECKING THE CLUTCH FLUID

To Check the Clutch Fluid

The clutch fluid level in the master cylinder should be checked when performing other under hood services. The system should be checked for leakage at the same time. Check to make certain that the clutch fluid level is always between the "MAX" and "MIN" level markings on the fluid reservoir. Fill as required. Fluid loss indicates a leak in the clutch system which should be inspected and repaired immediately.

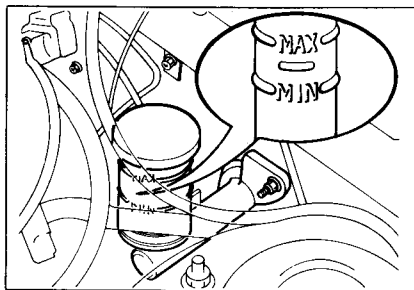

ZG13B1-A

To Replace the Fluid

Recommended brake fluid conforming to DOT 3 should be used. The reservoir cap must be fully tightened to avoid contamination from foreign matter or moisture.

NOTE:

Do not allow petroleum base fluid to contaminate the brake fluid. Seal damage will result.

WARNING

Use caution when handling brake fluid. It can damage your vision if you get it in your eyes. It will also damage your vehicle's paint if spilled on it and not removed immediately.

DO-IT-YOURSELF MAINTENANCE

ZG14A1-A

AIR CONDITIONER CARE

Keeping the Condenser Clean

The air conditioner condenser (and engine radiator) should be checked periodically for accumulation of dirt, dead insects, leaves, etc. These can interfere with maximum cooling efficiency. When removing such accumulations, brush or hose them away carefully to avoid bending the cooling fins.

ZG14B1-A

Checking the Compressor Drive Belt

When the air conditioner is being used regularly, the compressor drive belt tension should be checked at least once a month.

To check the drive belt tension, press down on the belt halfway between the engine crankshaft and compressor pulleys. Pressing with your finger, you should not be able to deflect this belt anymore than one-half inch. If you have the instruments to check it, with a force of 22 lb. (98N), the deflection should be 0.31~0.39 inches (8~10 mm). If the belt is too loose, have it adjusted by your Hyundai dealer.

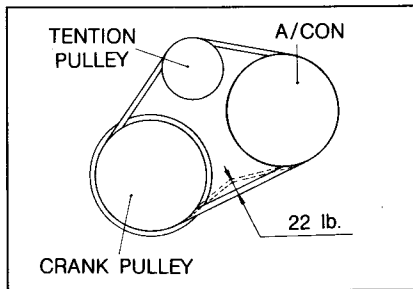

ZG14C1-A

Checking the Refrigerant

1. Start the engine and let it run at fast idle for several minutes with the air conditioner set at one of its colder settings.
2. Open the hood and check two hoses by touching with your fingers. One line is the evaporator inlet, the other is the outlet. If there is the temperature difference between two hoses, the refrigerant is low and the system should be recharged by your Hyundai dealer.

CAUTION:

Running the air conditioning system for extended periods of time with a low refrigerant level may damage the compressor.

ZG14D1-A

Lubrication

To lubricate the compressor and the seals in the system, the air conditioner should be run for at least 10 minutes each week. This is particularly important during cool weather when the air conditioning system is not otherwise in use.

DO-IT-YOURSELF MAINTENANCE

ZG15A1-A

CHECKING STEERING WHEEL FREEPLAY

To check the steering wheel freeplay, stop the car with the wheels pointed straight ahead and gently move the steering wheel back and forth. Use very light finger pressure and be sensitive to changes in resistance that mark the limits of the freeplay.

If the freeplay is greater than specified, have it inspected by your Hyundai dealer and adjusted or repaired if necessary.

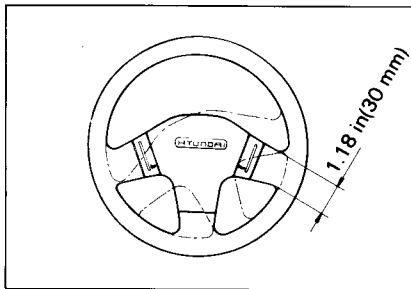

ZG16A1-A

CHECKING CLUTCH PEDAL FREEPLAY

With the engine off, press lightly on the clutch pedal until you feel a change in resistance. This is the clutch pedal freeplay.

The freeplay should be within the limits specified. In the illustration below if it is not, have it inspected by your Hyundai dealer and adjusted or repaired if necessary.

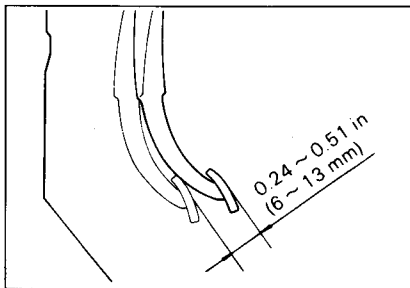

ZG17A1-A

CHECKING BRAKE PEDAL FREEPLAY

With the engine off, press down on the brake pedal several times to reduce the vacuum in the brake booster.

Then, using your hand, press down slowly on the brake pedal until you feel a change in resistance. This is the brake pedal freeplay.

The freeplay should be within the limits specified in the illustration below. If it is not, have it inspected by your Hyundai dealer and adjusted or repaired if necessary.

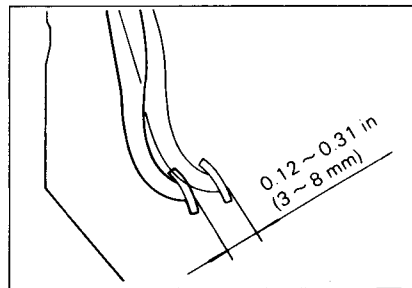

DO-IT-YOURSELF MAINTENANCE

ZG18A1-A

CHECKING BRAKE PEDAL CLEARANCE

You need a helper to check the brake pedal clearance. With the engine running, have your helper press down on the brake pedal several times and then hold it down with a force of about 110 lbs (50 kg, 490 N). The brake pedal clearance is the distance from the top surface of the brake pedal to the asphalt sheeting under the floor mat.

If the brake pedal clearance is not within the limits specified in the illustration, have it inspected by your Hyundai dealer and adjusted or repaired if necessary.

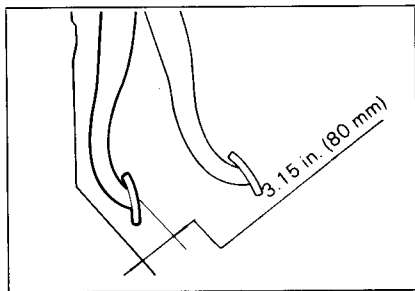

ZG19A1-A

CHECKING DRIVE BELTS

Drive belts should be checked periodically for proper tension and adjusted if necessary. At the same time, belts should be examined for cracks, wear, fraying or other evidence of deterioration and replaced if necessary. Belt routing should also be checked to be sure there is no interference between the belts and other parts of the engine.

After a belt is replaced, the new belt should be adjusted again after two or three weeks to eliminate slack resulting from initial stretching after use.

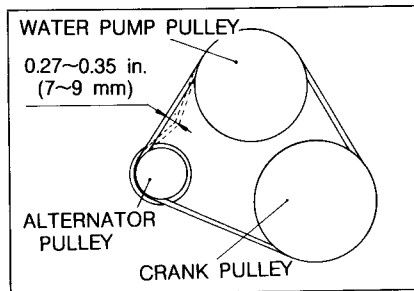

ZG20A1-A

CHECKING AND REPLACING FUSES

Replacing a Fusible Link

A fusible link will melt if the electrical circuits from the battery are ever overloaded, thus preventing damage to the entire wiring harness. (This could be caused by a short in the system drawing too much current.) If this ever happens, have a Hyundai dealer determine the cause, repair the system and replace the fusible link. The fusible links are located in a holder next to the battery for easy inspection.

CAUTION:

When replacing a fusible link, never use anything but a new fusible link with the same or lower amperage rating. Never use a piece of wire or a higher-rated fusible link. This could result in serious damage and create a fire hazard.

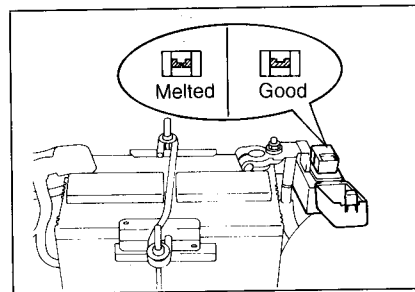

DO-IT-YOURSELF MAINTENANCE

ZG20B1-A

Replacing Accessory Fuse

The fuse box for the lights and other electrical accessories will be found low on the dashboard on the driver's side. Inside the box you will find a list showing the circuits protected by each fuse.

If any of your car's lights or other electrical accessories stop working, a blown fuse could be the reason. If the fuse has burned out, you will see that the metal strip inside the fuse has burned through. If you suspect a blown fuse, follow this procedure:

1. Turn off the ignition and all other switches.
2. Open the fuse box and examine each fuse. Remove each fuse by pulling it toward you (a small "fuse puller" tool is contained in the fuse box to simplify this operation).

3. Be sure to check all other fuses even if you find one that appears to have burned out.
4. Replace the blown fuse by pressing a new fuse of the same rating into place. The fuse should be a snug fit. If it is not, have the fuse clip repaired or replaced by a Hyundai dealer. If you do not have a spare fuse, you may be able to borrow a fuse of the same or lower rating from an accessory you can temporarily get along without (the radio or cigarette lighter, for example). Always remember to replace the borrowed fuse.

CAUTION:

A burned-out fuse indicates that there is a problem in the electrical circuit. If you replace a fuse and it blows as soon as the accessory is turned on, the problem is serious and should be referred to a Hyundai dealer for diagnosis and repair. Never replace a fuse with anything except a fuse with the same or a lower amperage rating. A higher capacity fuse could cause damage and create a fire hazard.

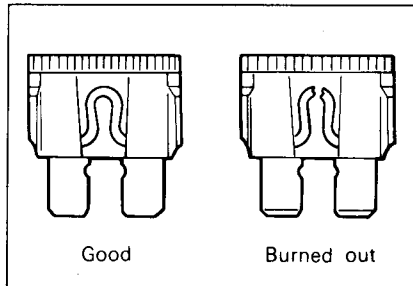
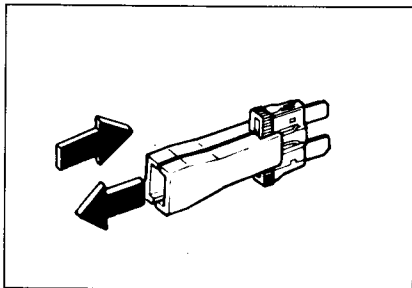
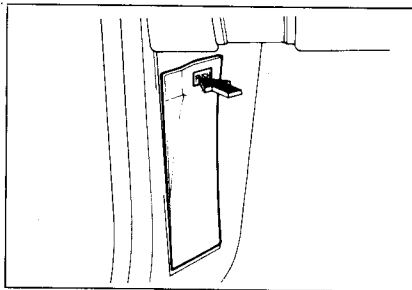

DO-IT-YOURSELF MAINTENANCE

ZG21A1-A

CHECKING THE BATTERY

WARNING

Batteries can be dangerous! When working with batteries, carefully observe the following precautions to avoid serious injuries.

The fluid in the battery contains a strong solution of sulfuric acid, which is poisonous and highly corrosive. Be careful not to spill it on yourself or the car. If you do spill battery fluid on yourself, immediately do the following:

- o If battery fluid is on your skin, flush the affected areas with water for at least 15 minutes and then seek medical assistance.
- o If battery fluid is in your eyes, rinse out your eyes with water and get medical assistance as soon as possible. While you are being driven to get medical assistance, continue to rinse your eyes using a sponge or soft cloth saturated with water.
- o If you swallow battery fluid, drink a large quantity of water or milk followed by milk of magnesia, eat a raw egg or drink vegetable oil. Get medical assistance as soon as possible.

While batteries are being charged (either by a battery charger or by the vehicle's alternator), they produce explosive gases. Always observe these warnings to prevent injuries from occurring:

- o Charge batteries only in a well ventilated area.
- o Do not permit flames, sparks or smoking in the area.
- o Keep children away from the area.

ZG21B1-A

Checking the Battery

Keep the battery clean. Any evidence of corrosion around the battery posts or terminals should be removed using a solution of household baking soda and warm water. After the battery terminals are dry, cover them with a light coating of grease.

To determine the battery charge, check the battery test indicator on top of the battery.

DG22A1-A

CHECKING ELECTRIC COOLING FANS

WARNING

The radiator fan is controlled by engine coolant temperature and may sometimes operate even after the ignition key has been turned off. Use extreme caution when working near the blades of the cooling fan, so that you are not injured by a rotating fan blade.

Checking the Engine Cooling Fan

The engine cooling fan should come on automatically if the engine coolant temperature is high.

Checking the Condenser Cooling Fan

The condenser cooling fan should come on automatically whenever the air conditioner is in operation.

DO-IT-YOURSELF MAINTENANCE

ZG23A1-A

POWER STEERING FLUID LEVEL

The power steering fluid level should be checked at those intervals specified in the vehicle maintenance schedule in Section 5. To check the steering fluid level, be sure the ignition is "OFF", then remove the dipstick, wipe it off, fully reinsert the dipstick and withdraw it again. Then note the highest point the fluid has reached on the dipstick. It should be between the upper "MAX" and lower "MIN" marks.

NOTE:

Grinding noise from power steering pump may be heard immediately after the engine is started in extremely cold condition (below -4°F). In this case, if the noise stops during warm up, there is no abnormal function in the system. This is due to a power steering fluid characteristic in extremely cold conditions.

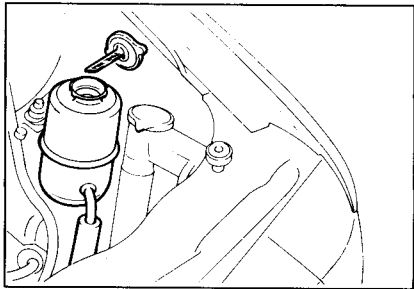

6-18

Recommended Fluid

Use ATF Dexron II type fluid.

NOTE:

Do not start the engine when the power steering oil reservoir is empty.

ZG23B1-A

POWER STEERING HOSES

It is suggested that you check the power steering hose connections for fluid leakage at those intervals specified in the vehicle maintenance schedule in Section 5.

The power steering hoses should be replaced if there is severe surface cracking, pulling, scuffing or worn spots. Deterioration of the hose could cause premature failure.

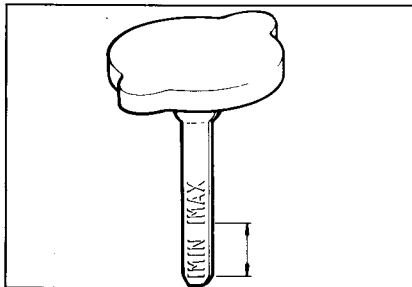

DO-IT-YOURSELF MAINTENANCE

ZG24A1-A

FOR MORE INFORMATION ABOUT YOUR HYUNDAI

If you desire additional information about maintaining and servicing your Hyundai, you may purchase a factory Shop Manual at your Hyundai dealer's parts department. This is the same manual used by dealership technicians and while it is highly technical it can be useful in obtaining a better understanding of your car and how it works.

ZG25A1-A

REPLACING LIGHT BULBS

Before attempting to replace a light bulb, be sure the switch is turned to the "OFF" position. The drawings in the next pages show how to reach light bulbs so they may be changed. Be sure to replace the burned-out bulb with one of the same number and wattage rating.

DG26A1-A

HEAD LIGHT

REPLACEMENT INSTRUCTIONS:

1. Allow the bulb to cool. Wear eye protection.
2. Always grasp the bulb by its plastic base, avoid touching the glass.
3. Unscrew the locking collar securing bulb.
4. Disconnect the power cord from the bulb base in the back of the headlight and remove the used bulb from the headlight.

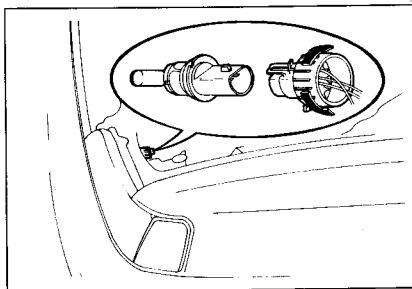

5. Remove the protective cap from the replacement bulb and install the new bulb by matching the plastic base with the head light hole. Reconnect the power cord and re-tighten the locking collar.
6. Use the protective cap and carton to promptly dispose of the old bulb.
7. Check for proper head light aim.

WARNING

This halogen bulb contains gas under pressure and if impacted could shatter, resulting in flying fragments. Always wear eye protection when servicing the bulb. Protect the bulb against abrasions or scratches and against liquids when lit. Turn on the bulb only after installing in a headlight. Replace the headlight if damaged or cracked. Keep the bulb out of the reach of children and dispose of the used bulb with care.

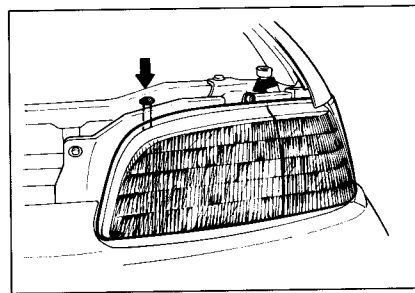

DO-IT-YOURSELF MAINTENANCE

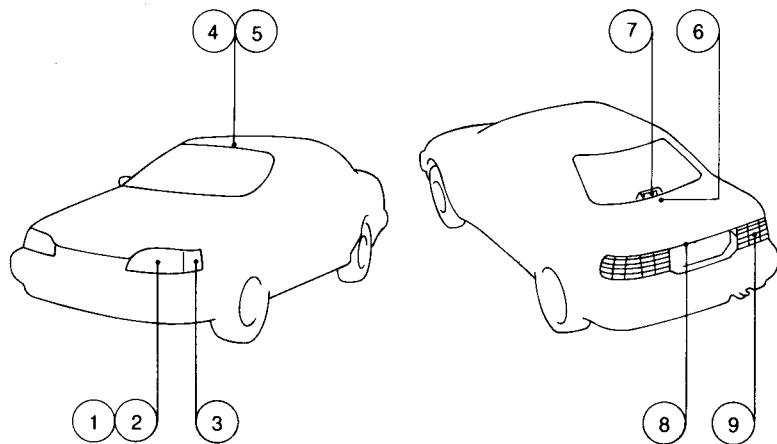

No.	Part Name	Wattage	No.	Part Name	Wattage	
1	Head Light	65/45	8	License Plate Light	8	
2	Front Turn Signal Light	28/8	9	Rear Combination Light	27	
3	Front Side Marker Light	5		Turn Signal Light		
4	Interior Light	10		Stop/Tail Light		28/8
5	Map Light	8		Back-up Light		27
6	Luggage Compartment Light	5		Side Mark Light	5	
7	High Mounted Rear Stop Light	17				

ZH00A1-A

7. EMISSION CONTROL SYSTEMS

EMISSION CONTROL SYSTEM

ZH01A1-A

EMISSION CONTROL SYSTEMS

Your Hyundai is equipped with an emission control systems to meet all requirements of the U.S. Environmental Protection Agency or California Air Resources Board.

There are three emission control systems which are as follows.

- (1) Crankcase emission control system
- (2) Evaporative emission control system
- (3) Exhaust emission control system

In order to assure the proper function of the emission control systems, it is recommended that you have your car inspected and maintained by an authorized Hyundai dealer in accordance with the schedule in this manual.

DH01B1-A

1. CRANKCASE EMISSION CONTROL SYSTEM

The positive crankcase ventilation system is used to prevent air pollution caused by blow-by gases being emitted from the crankcase.

This system supplies fresh air to the crankcase through the air cleaner. Inside the crankcase, fresh air mixes with blow-by gases, which then pass through the PCV valve into the intake system.

ZH01C1-A

2. EVAPORATIVE EMISSION CONTROL SYSTEM

The Evaporative Emission Control System is designed to prevent fuel vapors from escaping into the atmosphere.

Canister

While the engine is inoperative, fuel vapors generated inside the fuel tank are absorbed and stored in the canister. When the engine is running, the fuel vapors absorbed in the canister are drawn into the engine through the purge control solenoid valve.

Purge Control Solenoid Valve (PCSV)

The purge control solenoid valve is controlled by the Electronic Control Unit (ECU) when the engine coolant temperature is low, and during idling, the PCSV closes so that evaporated fuel is stored in the surge tank. After the engine warms-up, and while driving, the PCSV opens allowing fuel vapor stored in the canister to enter the induction system.

DH01D2-A

3. EXHAUST EMISSION CONTROL SYSTEM

The Exhaust Emission Control System is a highly effective system which controls exhaust emissions while maintaining good vehicle performance.

DH03A2-A

EGR System

This system helps control oxides of nitrogen by recirculating a part of the exhaust gas into the engine, thereby reducing cylinder combustion temperature.

EMISSION CONTROL SYSTEM

DH02A2-A

Catalytic Converter

All Hyundai vehicles are equipped with a monolith type three-way catalytic converter to reduce the carbon monoxide, hydrocarbons and nitrogen oxides contained in the exhaust gas.

Exhaust gases passing through the catalytic converter may cause it to operate at a very high temperature. The introduction of large amounts of unburned gasoline into the exhaust may cause the catalytic converter to overheat and create a fire hazard. This risk may be reduced by observing the following.

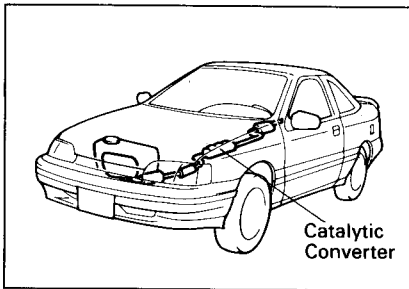

- o Use unleaded fuel only.
- o Maintain the engine in good operating condition. Extremely high converter temperatures can result from improper operation of the electrical, ignition or Multi Point Fuel Injection System.
- o If your engine stalls, pings, knocks, or is hard to start, have your Hyundai dealer inspect and repair the problem as soon as possible.
- o Avoid driving with a very low fuel level. Running out of gasoline may cause the engine to misfire and result in damage to the catalytic converter.
- o Avoid idling the engine for periods longer than 10 minutes.
- o The Vehicle should not be pushed or pulled to get started.
This may cause the catalytic converter to overheat and create a fire hazard.
- o Do not touch the catalytic converter or any other part of the exhaust system while the catalytic converter is hot. Shut off the engine, wait for at least one hour before touching the catalytic converter or any other part of the exhaust system.
- o Remember that your Hyundai dealer is your best source of assistance.

Z100A1-A

8. THINGS YOU SHOULD KNOW

**Consumer Information
Reporting Safety Defects**

CONSUMER INFORMATION

D101A1-A

VEHICLE IDENTIFICATION NUMBER (VIN)

The vehicle identification number (VIN) is the number used in registering your car and in all legal matters pertaining to its ownership, etc. It can be found in three different places on your car:

1. On the left top side of the instrument panel where it can be seen by looking down through the windshield.
2. On the identification plate attached to the engine side of the firewall between the engine and passenger compartments.
3. On the lower side of the center pillar outer panel.

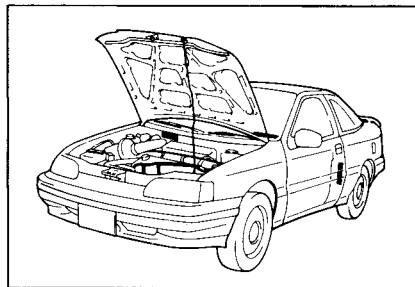

Z101B1-A

Engine Number

The engine number is stamped on the engine block as shown in the drawing.

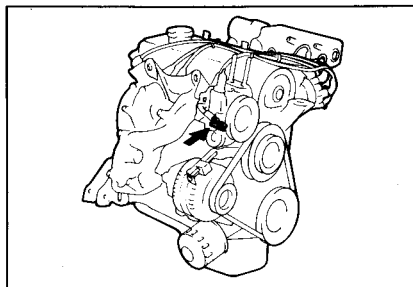

Z101C1-A

TIRE INFORMATION

The tires supplied on your new Hyundai are chosen to provide the best performance for normal driving.

Z102A1-A

RECOMMENDED INFLATION PRESSURES

The tire label located on the left door inner panel gives the tire pressures recommended for your car. These pressures were chosen to provide the most satisfactory combination of ride comfort, tire wear and stability under normal conditions.

Tire pressures should be checked at least monthly. Proper tire inflation pressures should be maintained for these reasons:

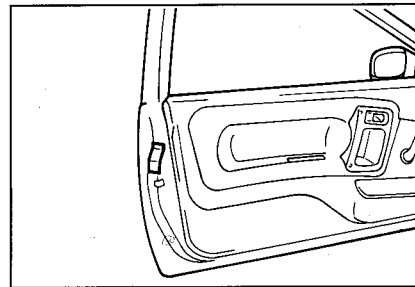

CONSUMER INFORMATION

- o Lower-than-recommended tire pressures cause uneven tread wear and poor handling.
- o Higher-than-recommended tire pressures increase the chance of damage from impacts and cause uneven tread wear.

CAUTION:

Always observe the following:

- o Check pressures when the tires are cold. That is, after the car has been parked for at least three hours and hasn't been driven more than one mile or 1.6 km since starting up.
- o Check the pressure of your spare tire each time you check the pressure of other tires.
- o Never overload your car. Be especially careful about overloading if you equip your car with a luggage rack or car top carrier.

Z103A1-A

SNOW TIRES

If you equip your car with snow tires, they should be the same size and have the same load capacity as the original tires.

Snow tires should be installed on all four wheels; otherwise, poor handling may result.

Snow tires should carry 4 psi (28 kPa) more air pressure than the pressure recommended for the standard tires on the tire label on the left door inner panel, or up to the maximum pressure shown on the tire sidewall whichever is less.

Do not drive faster than 75 mph (120 km/h) when your car is equipped with snow tires.

Z104A2-A

TIRE CHAINS

CAUTION:

The chains should not be used on P 185/60 HR 14 tires. With these tires there is not sufficient clearance for chains between the tires and other vehicle components and damage may result.

Tire chains should be installed on the front wheels. Be sure that the chains are the proper size and that they are installed in accordance with the manufacturer's instructions.

To minimize tire and chain wear, do not continue to use tire chains when they are no longer needed.

CAUTION:

When driving on roads covered with snow or ice, drive at less than 20 mph (30 km/h).

CONSUMER INFORMATION

Z105A1-A

TIRE ROTATION

Tires should be rotated every 6,000 miles (10,000 km). If you notice that tires are wearing unevenly between rotations, have the car checked by a Hyundai dealer so the cause may be corrected.

After rotating, adjust the tire pressures and be sure to check wheel nut tightness.

CAUTION:

- o Do not use the temporary spare tire for tire rotation.
- o Do not mix bias-ply and radial-ply under any circumstances. This may cause dangerous handling characteristics.

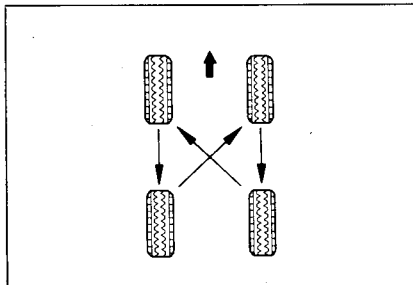

8-4

Z106A1-A

TIRE BALANCING

A tire that is out of balance may affect handling and tire wear. The tires on your Hyundai were balanced before the car was delivered but may need balancing again during the years you own the car.

Whenever a tire is dismantled for repair, it should be rebalanced before being reinstalled on the car.

Z106B1-A

TIRE TRACTION

Tire traction can be reduced if you drive on worn tires, tires that are improperly inflated or on slippery road surfaces. Tires should be replaced when tread wear indicators appear. To reduce the possibility of losing control, slow down whenever there is rain, snow or ice on the road.

Z106C1-A

WHEN TO REPLACE TIRES

CAUTION:

Driving on worn-out tires is dangerous! Worn-out tires can cause loss of braking effectiveness, steering control and traction. When replacing tires, never mix radial and bias-ply tires on the same car. If you replace radial tires with bias-ply tires, they must be installed in sets of four.

The original tires on your car have tread wear indicators. The tread wear indicators appear when the tread depth is 0.06 in. (1.6 mm). The tire should be replaced when these appear as a solid bar across two or more grooves of the tread. Always replace your tires with those of the recommended size. If you change wheels, the new wheel's rim width and offset must be those specified by Hyundai.

CAUTION:

Using tires and wheels of other than the recommended sizes cause poor handling and can be dangerous!

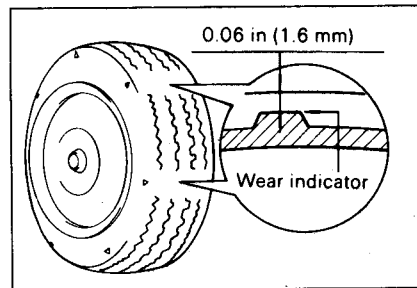

CONSUMER INFORMATION

Z107A2-A

SPARE TIRE AND TOOLS

Your Hyundai is delivered with the following:

Spare tire and wheel
Wrench
Jack
Bar

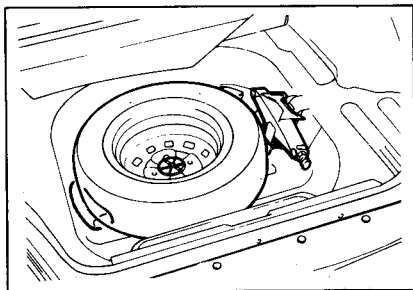

Z108A1-A

SHOP MANUAL

A Hyundai Shop Manual is available from your authorized Hyundai dealer. It's written for the professional technicians, but is simple enough for most mechanically-inclined owners to understand.

ZA01A2-A

WARRANTIES FOR YOUR HYUNDAI VEHICLE

- o New vehicles 36 months/36,000 Mile Limited Warranty
- o Anti-Perforation Limited Warranty
- o Emission Defect Warranty - Federal Vehicle
- o California Emission Control System Warranty (If applicable)
- o Emission Performance Warranty - Federal Vehicle
- o Replacement Parts and Accessories Limited Warranty
- o Tire Warranty

NOTE

Detailed warranty information is provided in your Hyundai Owner's Handbook.

Z109A1-A

CONSUMER INFORMATION

This consumer information has been prepared in accordance with regulations issued by the National Highway Traffic Safety Administration of the U.S. Department of Transportation. It provides the purchasers and/or prospective purchasers of Hyundai automobiles with information on uniform tire quality grading. Your Hyundai dealer will help answer any questions you may have as you read this information.

CONSUMER INFORMATION

Z110A1-A

Uniform tire quality grading

DOT quality grades — All passenger vehicle tires must conform to Federal Safety Requirements in addition to these grades. These quality grades are molded on the sidewall.

Treadwear — The treadwear grade is a comparative rating based on the wear rate of the tire when tested under controlled conditions on a specified government test course. For example, a tire graded 150 would wear one and a half (1 - 1/2) times as well on the government course as a tire graded 100.

The relative performance of tires depends upon the actual conditions of their use, however, and may depart significantly from the norm due to variations in driving habits, service practices and differences in road characteristics and climate.

Traction A, B, C — The traction grades, from highest to lowest, are A, B, and C, and they represent the tire's ability to stop on wet pavement as measured under controlled conditions on specified government test surfaces of asphalt and concrete. A tire marked C may have poor traction performance.

WARNING

The traction grade assigned to this tire is based on braking (straight ahead) traction tests and does not include cornering (turning)traction.

Temperature A, B, C — The temperature grades are A (the highest), B, and C, representing the tire's resistance to the generation of heat and its ability to dissipate heat when tested under controlled conditions on a specified indoor laboratory test wheel. Sustained high temperature can cause the material of the tire to degenerate and reduce tire life, and excessive temperature can lead to sudden tire failure. The grade C corresponds to a level of performance which all passenger car tires must meet under the Federal Motor Vehicle Safety Standard No. 109. Grades B and A represent higher levels of performance on the laboratory test wheel than the minimum required by law.

WARNING

The temperature grade for this tire is established for a tire that is properly inflated and not overloaded. Excessive speed, under inflation, or excessive loading, either separately or in combination, can cause heat buildup and possible tire failure which could result in an accident.

REPORTING SAFETY DEFECTS

dal Motor vehicles are designed and manufactured to meet or exceed all applicable safety standards.

For your safety, however, we strongly urge you to read and follow all directions in this Owner's Manual, particularly the information under the headings "NOTE", "CAUTION" and "WARNING".

If, after reading this manual, you have any questions regarding the operation of your vehicle, please contact your nearest Hyundai Motor America Regional Office as listed below:

Eastern Region: Connecticut, Delaware, Maine, Maryland, Massachusetts, New Hampshire, New Jersey, New York, Pennsylvania, Rhode Island, Vermont, Virginia, West Virginia.

Eastern Region
1100 Cranbury South River Road
Jamesburg, NJ 08831
(800) 633-5151

Southern Region: Alabama, Arkansas, Florida, Georgia, Louisiana, Mississippi, North Carolina, South Carolina, Oklahoma, Tennessee, Texas.

Southern Region
240 North Thornton Road
Lithia Springs, GA 30057
(800) 633-5151

Central Region: Illinois, Indiana, Missouri,

Iowa, Kansas, Kentucky, Michigan, Minnesota, Nebraska, North Dakota, South Dakota, Ohio, Wisconsin.

Central Region
700 No. Enterprise Street
Aurora, Illinois 60504
(800) 633-5151

Western Region: Alaska, Hawaii, Arizona, California, Colorado, Idaho, Montana, Nevada, New Mexico, Oregon, Texas, Utah, Washington, Wyoming.

Western Region
10550 Talbert Avenue
P. O. Box 20850
Fountain Valley, California 92728-0850
(800) 633-5151

Z111A1-A

Reporting Safety Defects

If you believe that your vehicle has a defect which could cause a crash or could cause injury or death, you should immediately inform the National Highway Traffic Safety Administration (NHTSA) in addition to notifying HYUNDAI MOTOR AMERICA. If NHTSA receives similar complaints, it may open an investigation, and if it finds that a safety defect exists in a group of vehicles, it may order a recall and remedy campaign. However, NHTSA cannot become involved in individual problems between you, your dealer, or HYUNDAI MOTOR AMERICA.

REPORTING SAFETY DEFECTS

To contact NHTSA, you may either call the Auto Safety Hotline toll-free at 1-800-424-9393 (or 366-0123 in Washington, D.C. area) or write to: NHTSA, U.S. Department of Transportation, Washington, D.C. 20590. You can also obtain other information about motor vehicle safety from the Hotline.

ZJ00A1-A

9. VEHICLE SPECIFICATIONS

VEHICLE SPECIFICATIONS

MEASUREMENT

Items		2 Door
Overall length		165.8 in. (4213 mm)
Overall width		64.02 in. (1626 mm)
Overall height (unladen)		52.28 in. (1328 mm)
Wheel base		93.82 in. (2383 mm)
Wheel tread	Front	54.72 in. (1390 mm)
	Rear	52.76 in. (1340 mm)

POWER STEERING

Type	Rack and pinion
Wheel free play	0~1.18 in. (0~30 mm)
Rack stroke	5.2 in. (132 mm)
Oil pump type	Vane type

FUEL SYSTEM

Fuel tank capacity	US.gal	Imp.gal	Liter
	11.9	9.9	45

TIRE

A type	P 175/70 R 13
B type	P 185/60 HR 14
Spare	Temporary

SUSPENSION

Type	Front	MacPherson strut with coil spring type
	Rear	Trailing arm with coil spring type

MANUAL TRANSAXLE

Gear ratio		KM 201
	1st	3.363
	2nd	1.947
	3rd	1.285
	4th	0.939
	5th	0.777
Oil capacity (US.qts, Imp.qts, Liter)		(1.9, 1.6, 1.8)

AUTO TRANSAXLE

Gear ratio		KM 176
	1st	2.846
	2nd	1.581
	3rd	1.000
	Over drive	0.685
Oil capacity (US.qts, Imp.qts, Liter)		(6.4, 5.4, 6.1)

ELECTRICAL

Battery	MF 12V 60AH	
Alternator	12V 75A	
Starter	Auto T/A	0.9 KW
	Manual T/A	0.7 KW

BRAKE

Type	Dual hydraulic with brake booster
Front brake type	Ventilated disc
Rear brake type	Drum
Parking brake	Cable operated on rear wheel

VEHICLE SPECIFICATIONS

ENGINE

ITEMS	SPECIFICATIONS	
Engine Type	4-Cylinder in-line OHC	
Idle Speed (RPM)	700±100	
Spark Plug	NGK	BUR6EA-11,BPR6ES-11
	CHAMPION	RN9YC4
Spark Plug Gap	0.039 to 0.043 in. (1.0 to 1.1 mm)	
Valve Clearance (Warm engine)	Intake v/v	0.006 in. (0.15 mm)
	Exhaust v/v	0.01 in. (0.25 mm)
Ignition Timing	BTDC 5° ± 2°	
Firing Order	1—3—4—2	

LUBRICATION CHART

Item		Oil & Grease Standard	Q'ty
Engine Oil	API SG	SAE 20W-20, 20W-40, 20W-50 (ABOVE 32°F OR 0°C)	Dry fill : (3.6 us-qts, 3.0 Imp-qts, 3.4 Liter)
	or	SAE 10W-30, 10W-40, 10W-50 (ABOVE-10°F OR-23°C)	
	SG/CD	SAE 5W-20(*1,*2), 5W-30, 5W-40 (BELOW 60°F OR 16°C)	Drain and refill
		*1. Restricted by driving condition and climate. *2. Not recommended for sustained high speed vehicle operation.	W/o oil filter: (2.7 us-qts, 2.3 Imp-qts, 2.6 Liter) W oil filter: (3.2 us-qts, 2.6 Imp-qts, 3.0 Liter)
Transaxle	Manual	API GL-4 SAE 75W/85W	(1.9 us-qts, 1.6 Imp-qts, 1.8 Liter)
	Auto	GENUINE HYUNDAI ATF AUTOMATIC TRANSMISSION FLUID or MOPAR ATF PLUS TYPE 7176, DIAMOND ATF SP	(6.4 us-qts, 5.4 Imp-qts, 6.1 Liter)
Power steering		ATF Dexron II	(0.95 us-qts, 0.79 Imp-qts, 0.9 Liter)
Brake fluid		DOT 3 equivalent	As required
Wheel bearing		Multipurpose grease NLGI-2, EP	As required
Coolant		Ethylene glycol base for aluminum radiator	(5.6 us-qts, 4.7 Imp-qts, 5.3 Liter)

ZK00A1-A

10. INDEX

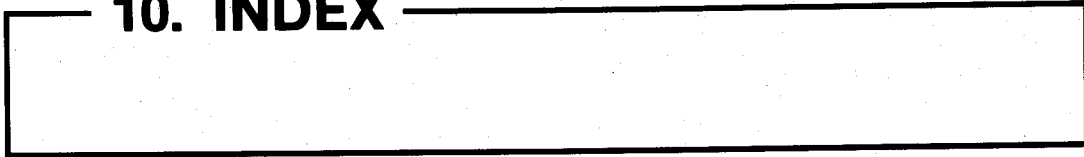

INDEX

- A** Air conditioner
—care 6-13
—manual 1-39
Air filter 6-8
Ashtray 1-24
Audio system 1-40~1-62
Automatic transaxle
—checking fluid 6-10~6-11
—operation 2-4
—overdrive switch 2-9
—normal/economy switch 2-8
- B** Balancing tires 8-4
Battery 6-17
Bi-level heating 1-37
Brake
—fluid 6-11~6-12
—lamp 1-30
—operation 2-9
—pedal play 6-14
—pedal clearance 6-15
"Breaking In" your new Hyundai 1-2
- C** Child protector locks 1-4
Child restraint system 1-12~1-14
Cigarette lighter 1-24
Cleaning
—interior 4-4
—exterior 4-2~4-3
Clock 1-23
Consumer information 8-1~8-6
Coolant
—changing 6-6~6-7
—recommended use 9-3
Cooling system
—checking 6-6
—fans 6-17
Corrosion protection 4-2
- D** Dashboard 1-17
Day-night mirror 1-28
Defroster
—rear window 1-23
—rotary type 1-38
Do-It-Yourself maintenance 6-1
Dome lamp 1-26
Door locks 1-3~1-4
Drink holder 1-24
Drive belts 6-15
Driving tips 2-3~2-12
- E** Economical driving 2-10
Electric cooling fans 6-17

INDEX

- Emission control system 7-1~7-3
- Emergency**
- flat tire 3-5~3-9
 - starting 3-2
 - towing 3-11
- Engine
- compartment 6-2
 - number 8-2
 - oil 6-4
 - starting 2-4
- F** Fan
- cooling 6-17
 - heater (rotary type) 1-35~1-38
- Flat tire** **3-5**
- Front seats 1-4~1-6
- Fuel
- filler cap 1-31
 - filler door release 1-30
 - requirements 1-2
- Fuses** **6-15~6-16**
- G** Gasohol 1-2
- Gasoline (see fuel) 1-2
- Gauges 1-19
- Glove box 1-26
- H** Hazard warning system 1-22
- Headlamp 6-19
- Headrests 1-5
- Heater
- rotary type 1-35~1-38
- High mount stop light 1-30
- Hood 1-31
- Horn 1-32
- I** Identification numbers 8-2
- Idle speed 9-3
- Ignition switch/steering lock 2-3
- Indicator lights 1-17
- Inflation pressure, tire 8-3
- Instrument cluster 1-16
- Instruments and controls 1-15
- Interior, cleaning 4-4
- Interior light 1-25
- Intermittent wiper 1-22
- J** **Jacking, operation** **3-7**
- Jump starting procedures** **3-2~3-3**
- K** Keys 1-3, 3-11
- L** Light bulb replacement 6-19
- Light controls 1-23

INDEX

- Locks 1-3~1-4
Lost keys 1-3
Lubricants 9-3
- M** Maintenance
—requirements 5-2
—Do-It-Yourself procedures 6-1~6-20
—schedules 5-3~5-5
Manuals, shop 8-5
MTBE 1-2
Mirrors
—day-night rear view 1-27
—outside rear view 1-26
—visor 1-31
- O** Odometer 1-20
Oil, engine
—adding 6-4
—filter 6-5
—changing 6-5
—checking 6-4
—overheating 3-3~3-4
- P** Parking brake 1-28
Power steering fluid 6-18
Pressure, tire (see left door inner panel) 8-3
- R** Radio/tape player 1-40~1-69
Rear seats 1-29
- 10-4
- Rear view mirror 1-28
Rear window defroster 1-23
Remote
—fuel filler door release 1-30
—trunk release 1-29
Reporting safety defects 8-7
Rheostat 1-23
Rotating tires 8-4
Room lamp 1-27
- S** Scheduled maintenance 5-3~5-5
Seats
—front 1-4~1-6
—rear 1-6
- Seat belts**
—care 1-8
—operating 1-10~1-12
—passive system 1-8~1-9
Service requirements 5-2
Shop manual 8-5
Snow chains 8-3
Snow tires 8-3
Spare tire 3-4
Spark plugs 6-7~6-8
Specifications 9-1~9-3
Speedometer 1-20
Starting procedures 2-3~2-4

INDEX

- Steering
 - column lock 2-3
 - tilt 1-32
- Stereo sound system 1-40~1-62
- Sunroof 1-25
- Sun visor 1-32
- Switches 1-21
- T** Tachometer 1-20
- Tires
 - balancing 8-4
 - chains 8-3
 - flat 3-5
 - information 8-2
 - pressure (see left door inner panel) 8-3
 - replacement 8-4
 - rotation 8-4
 - snow tires 8-3
 - traction 8-4
- Towing**
 - a trailer 2-13
 - your car 3-9~3-10
- Transaxle
 - automatic 2-6~2-9
 - automatic transaxle fluid check 6-10~6-11
 - manual transaxle fluid check 6-9~6-10
- Trip odometer 1-20
- Trunk 1-29
- V** Vehicle identification number 8-2
- Ventilation
 - rotary type 1-35~1-40
- VIN 8-2
- Visors 1-32
- W** Warning lights 1-18
- Washing and waxing 4-3~4-4
- Wheels
 - removal and replacement 3-6~3-9
- Windows 1-6~1-7
- Wiper blades 6-9
- Wiper/washer fluid 6-9

This Owner's Manual should be considered a part of the car and remain with it when it is sold for the use of the next owner.

OWNER'S I.D.			
ORIGINAL OWNER	_____		
ADDRESS	_____		
CITY	STATE	ZIP CODE	_____
DELIVERY DATE	_____		
	(Date Sold to Original Retail Purchaser)		
DEALER NAME	DEALER NO.	_____	
ADDRESS	_____		
CITY	STATE	ZIP CODE	_____

All information in this Owner's Manual is current at the time of publication.

However, Hyundai reserves the right to make changes at any time so that our policy of continual product improvement may be carried out.

SERVICE STATION INFORMATION FUEL:

UNLEADED gasoline only
Pump Octane Rating of 87 (Research Octane Number 91) or higher.

FUEL TANK CAPACITY

Original, gal (Imp.gal., liter) 11.9 (9.9,45)

TIRE PRESSURE:

See the label on the left door inner panel.

OTHER TIRE INFORMATION:

See pages 8-2 through 8-6.

HOOD RELEASE:

Pull handle under left side of dash.

ENGINE OIL:

API grade SG or SG/CD multigrade and fuel efficient oil. Use SAE 10W-30 or 10W-40 if normal temperatures are above-10°F (-23°C). For other viscosity recommendations. See page 6-4.

MANUAL TRANSAXLE:

API GL-4 SAE 75W/85W Oil level should be up to filler-bolt hole in the differential housing.

AUTOMATIC TRANSAXLE:

Apply the parking brake, with the engine running, shift the selector lever through all ranges and return to "N". Then check the level of fluid on the dipstick. Use GENUINE HYUNDAI ATF AUTOMATIC TRANSMISSION FLUID, MOPAR ATF PLUS TYPE 7176 or DIAMOND ATF SP.

QUICK INDEX

o Car will not start	3-2
o Flat tire	3-5
o Warning light/chime comes on	1-17
o Engine overheats	3-3
o Towing of your vehicle	3-10
o Starting the engine	2-4
o Driving tips for first 1,200 miles (2,000 km)	1-2
o Vehicle maintenance schedule	5-3
o Reporting safety defects'	8-7